



REV. E

Cooler is Better!™



USER'S MANUAL

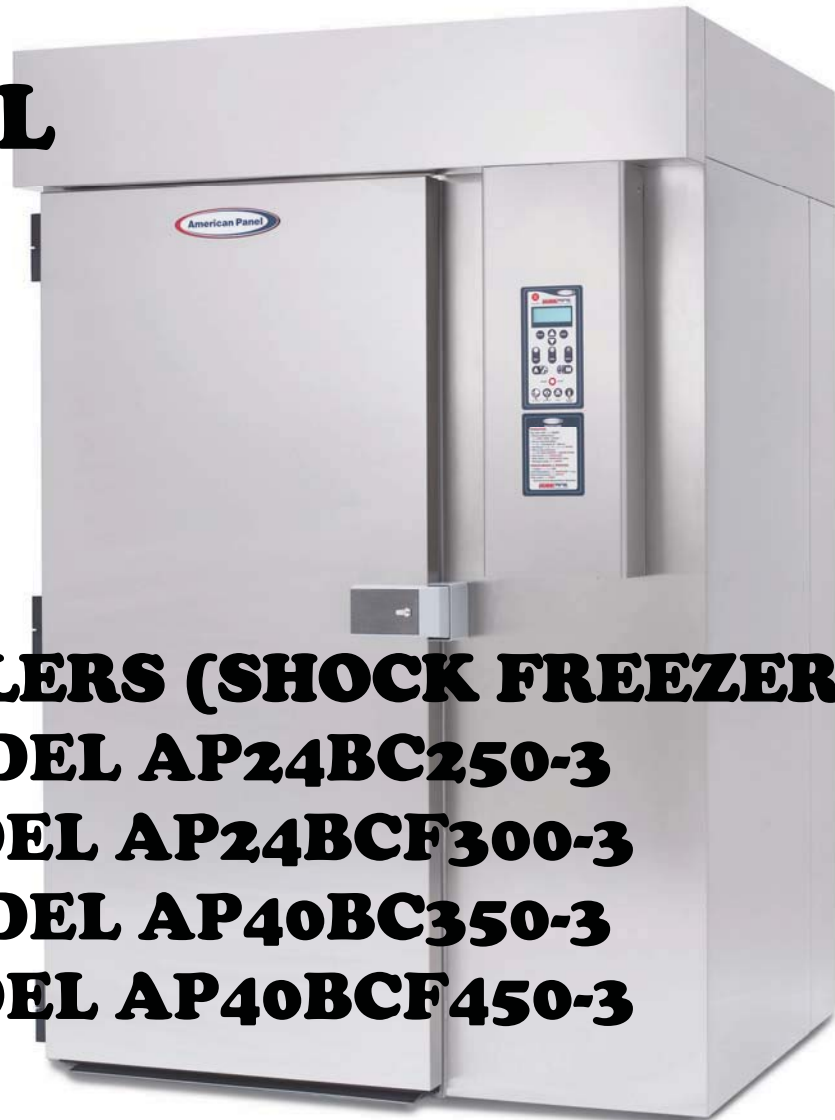

BLAST CHILLERS (SHOCK FREEZERS)

MODEL AP24BC250-3

MODEL AP24BCF300-3

MODEL AP40BC350-3

MODEL AP40BCF450-3

American Panel Corporation
5800 S.E. 78th Street, Ocala, Florida 34472-3412
Phone: (352) 245-7055 Fax: (352) 245-0726
E-mail: service@americanpanel.com

INDEX

INTRODUCTION	3
CONTROLLER FEATURES	3
OPERATING MODES	3
AUTOMATIC MODE	3
MANUAL MODE	4
OPERATING CYCLES	4
PRINTER (OPTIONAL)	4
PC CONNECTION (OPTIONAL)	4
INSTALLATION OF REMOTE UNITS	5
REQUIREMENTS TO BE MET DURING INSTALLATION (8 STEPS)	5
INSTALLATION AT THE SAME LEVEL	5
INSTALLATION AT DIFFERENT LEVELS	6
CONNECTION PIPING FOR REMOTE CONDENSING UNITS	6
INSTALLATION	7
WARNINGS	7
PREPARATION	7
INSTALLATION	7
LOCATION	7
DIMENSIONS	7
ELECTRICAL AND REFRIGERATION SPECIFICATIONS	8
CONNECTION TO THE REMOTE UNIT	8
CONDENSATE DRAINAGE CONNECTION	8
VERIFYING CORRECT INSTALLATION	8
SPACES AROUND THE CABINET	9
STARTING & TESTING THE UNIT	9
USING THE HURRICHILL™ TECHNOLOGY	10
BLAST CHILLING	10
SHOCK FREEZING	10
SOFT CHILL CYCLE	10
HARD CHILL CYCLE	10
SHOCK FREEZE CYCLE	10
PANNING AND LOADING	11
PANNING	11
LOADING	11
CONTROL PANEL FOR MODELS AP24 & AP40 BLAST CHILLERS / SHOCK FREEZERS	12
KEYBOARD KEYS	13
KEY COMBINATIONS	13
PROGRAMMING	14
1. INITIAL PROGRAMMING	14
2. PROGRAMMING THE CYCLES	17
AUTOMATIC SOFT CYCLE PARAMETERS PROGRAMMING	18
AUTOMATIC HARD CYCLE PARAMETERS PROGRAMMING	18
AUTOMATIC SHOCK CYCLE PARAMETERS PROGRAMMING	19
UV LIGHT CYCLE PARAMETERS PROGRAMMING	20
DEFROST CYCLE PARAMETERS PROGRAMMING	21
HEATED PROBE CYCLE PARAMETERS PROGRAMMING	21

MANUAL SOFT CYCLE PARAMETERS PROGRAMMING	22
MANUAL HARD CYCLE PARAMETERS PROGRAMMING	23
MANUAL SHOCK CYCLE PARAMETERS PROGRAMMING	24
3. RECIPE NAME PROGRAMMING	25
OPERATION	26
1. AUTOMATIC MODE - SOFT CHILL	26
2. MANUAL MODE - SOFT CHILL	27
3. HARD CHILL CYCLE	28
4. SHOCK FREEZE CYCLE	29
5. UV (STERILIZATION) CYCLE	29
6. DEFROST CYCLE	29
7. HEATED FOOD PROBE	30
8. PREPARING AND USING THE OPTIONAL PRINTER	31
9. TO CLEAR DATA	32
PRINTER	32
LOADING A ROLL OF PAPER	33
REMOVING A ROLL OF PAPER	33
OPERATING THE PRINTER	33
MAINTENANCE	33
REPLACING THE RIBBON (NO PAPER IN THE PRINTER)	33
REPLACING THE RIBBON (WITH PAPER IN THE PRINTER)	34
MAINTENANCE AND CLEANING	34
CLEANING THE CONDENSER	34
CLEANING THE STORAGE COMPARTMENT	35
WIRING DIAGRAMS	35
COMPUTER CONNECTION	39
PARTS LIST	40
STANDARD WARRANTY	41
ORDERING PRINTER SUPPLIES (RIBBON & PAPER)	42

INTRODUCTION

Blast Chiller Models AP24BC250-3 and AP40BC350-3 are used to rapidly chill cooked foods to temperatures suitable for refrigerated storage. They are capable of lowering the core temperature of most foods from 160° F to 40° F in 90 minutes. Chiller/Freezer Models AP24BCF300-3 and AP40BCF450-3 have the same chilling capabilities as the Blast Chiller Models and when the shock freezing option is selected, are capable of lowering the core temperature of most foods from 160° F to 0° F in 4 hours. Food is loaded into 12" x 20" x 2-1/2" pans. AP24 and AP40 models are sized to accept one rack containing up to 40 pans (24 for AP24). All models can have as options: UV sterilization, an integral temperature recording device (printer) and 2 or 4 food probes instead of one. All models employ a high velocity flow of cooled air to assure even cooling of the food product, and to quickly bring the food temperature through the danger zone in which bacteria multiply rapidly. This is done in accordance with the requirements of HACCP, FDA and all applicable state regulations.

CONTROLLER FEATURES

The electronic control system is solid state and is based on the latest microprocessor technology. The display is VFD Industrial Type. It displays (4) lines of 20 characters each and allows operator viewing from any angle. The display is programmed to show clear step-by-step instructions and operating data. It is capable of storing 250 sets of data and 150 recipes. The unit has built-in safety and self-diagnostic systems. The controller notifies the operator if various faults, as listed below, should occur:

- Power supply failure / Restoration of power
- Faulty air temperature probe
- Faulty food temperature probe
- High air temperature (above 140° F)
- Low air temperature (below -35° F)
- High food temperature (above 180° F)
- Low food temperature (below 35° F)

As an option, the unit can be operated by a PC. The PC interface allows the operator to remotely program the unit, operate it, download the data and print the data.

OPERATING MODES

The operator can choose from the following modes:

AUTOMATIC MODE

This is the preferred mode, in which all the food probes are active and take part in controlling the chilling or freezing process. The cycle will never proceed to its next step until all the probes have reached their set breaking temperatures. The operator needs only to select the recipe number of the food to be controlled by each probe (up to 150 recipes can be programmed), then insert each probe into its food. It is recommended that the operator remove the food when its temperature starts to flash and the display shows "Ready". The unit will automatically switch into holding mode (cavity air temperature between 35° F and 42° F) when all the food have reached the end cycle programmed temperature.

MANUAL MODE

Operating time is set manually, by the operator, for the meal that has been chosen. Air temperature is controlled by the air probe. If the food probes have been inserted into the food they will provide temperature readouts only. The unit will automatically switch into the holding mode at the end of the cycle.

OPERATING CYCLES

The operator can choose from the following 6 operating cycles:

MODE	FOOD TEMP. AT END	USES	NOTES:
SOFT CHILL	38° F TO 40° F	FOR LOW DENSITY FOODS	AIR TEMP. IS 28° F TO 35° F
HARD CHILL	38° F TO 40° F	FOR MEDIUM & HIGH DENSITY FOODS	AIR TEMP. STARTS AT 0° F, RISES TO 28° F TO 35° F WHEN FOOD CORE TEMP. REACHES 60° F
SHOCK FREEZE	0° F	FOR LONGER STORAGE	AIR TEMP. IS -25° F
DEFROST	N/A	TO DEFROST THE EVAPORATOR, NOT THE FOOD	USE AFTER SHOCK FREEZING CYCLE
UV (optional)	N/A	TO STERILIZE THE CAVITY, NOT THE FOOD	USE WHEN DESIRED
HEAT PROBE	N/A	TO HEAT THE FOOD PROBE	ALLOWS EASIER EXTRACTION FROM THE FOOD

NOTE: All Chill & Freeze Cycles automatically go into HOLDING MODE when the selected temperature is reached and remain there until the operator stops the cycle.

PRINTER (OPTIONAL)

An optional strip recorder provides a record of the unit’s operating parameters during the cycle and the following holding period. The information recorded includes date, time, cycle identification, product identification and product core temperature at prescribed intervals.

PC CONNECTION (OPTIONAL)

The unit can be programmed and operated from a remote PC via modem and software (Windows 95, 98, NT, XP). Maximum distance is 4000 ft. Full instructions are supplied on a computer disc, which is furnished when the computer connection is ordered.

INSTALLATION OF REMOTE UNITS

REQUIREMENTS TO BE MET DURING INSTALLATION (8 STEPS)

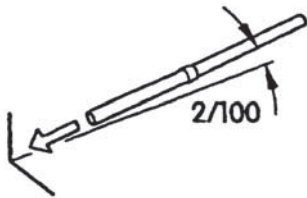

COMPRESSOR

1. Inclination of the piping.



3. Airtight welding.

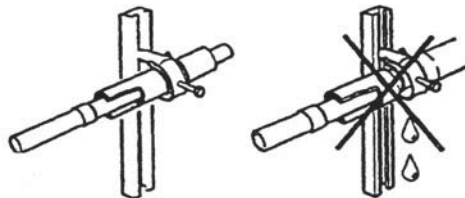

FIG. 1

2. Fastening of brackets on insulated piping.

FIG. 2

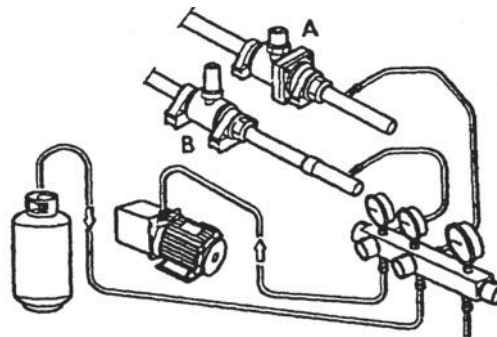

FIG. 3

4. Create the vacuum and load the line.

FIG. 4

5. Check for leaks.

6. Open the shut-off valves (A & B, FIG.4) on both sides of remote unit and of cabinet.

7. Check the exact load of refrigerant in the liquid passage gauge.

8. Make sure all the refrigerant taps are open.

INSTALLATION AT THE SAME LEVEL

If the condensing unit is going to be installed at the same level with the cabinet, follow the instructions in FIG. 5

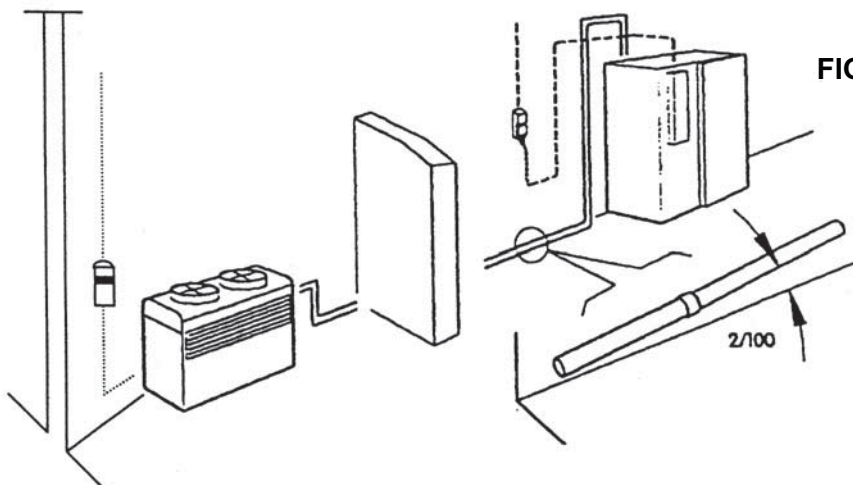

FIG. 5

INSTALLATION AT DIFFERENT LEVELS

If the remote condensing unit is installed at a higher level than the cabinet (FIG. 6) insert a siphon in the return line at every 6 ft. of difference in height. If the remote condensing unit is installed at a lower level than the cabinet (FIG. 7) it is not necessary to insert any siphons.

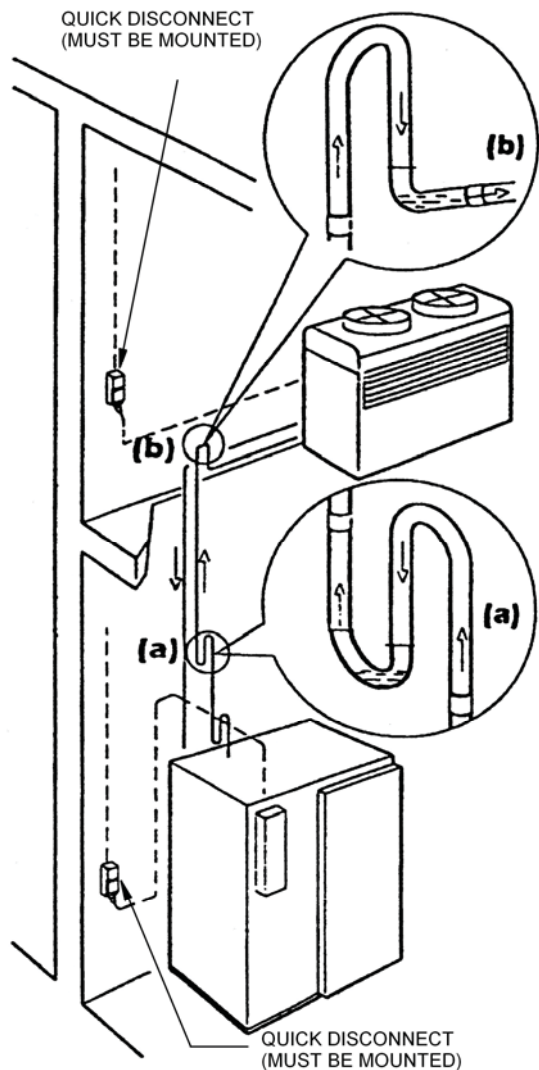

FIG. 6

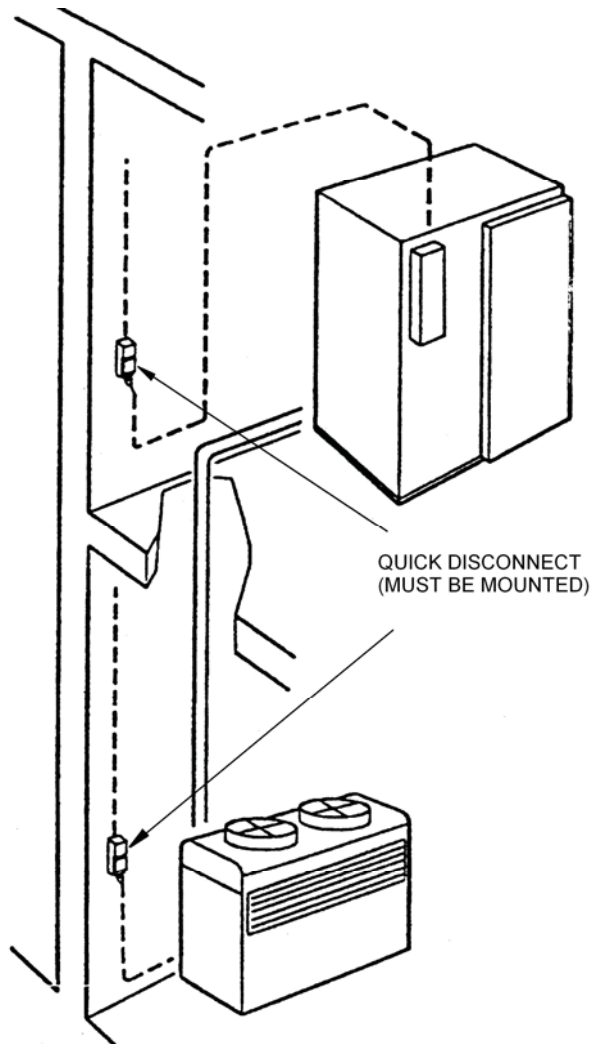

FIG. 7

Insert a siphon at the beginning (a) and at the end (b) of each riser

CONNECTION PIPING FOR REMOTE CONDENSING UNITS

MODEL	SUPPLY LINE DIA.	INTAKE LINE DIA.
AP24BC250-3	1/2"	1-1/8"
AP24BCF300-3	5/8"	1-3/8"
AP40BC350-3	5/8"	1-3/8"
AP40BCF450-3	7/8"	1-5/8"

INSTALLATION

WARNINGS

READ ALL OF THE INSTRUCTIONS IN THIS MANUAL BEFORE YOU ATTEMPT TO INSTALL THE EQUIPMENT.

ALWAYS DISCONNECT THE UNIT FROM THE POWER SOURCE BEFORE PERFORMING ANY SERVICE OR MAINTENANCE.

INSTALLATION AND SERVICE MUST BE PERFORMED BY A QUALIFIED SERVICE AGENCY APPROVED & AUTHORIZED BY AMERICAN PANEL CORPORATION. DOING OTHERWISE MAY VOID THE WARRANTY.

Note: Any changes made to the equipment without authorization from the factory will void the warranty.

PREPARATION

Check the integrity of the unit once it is unpacked.

Check that the available power supply corresponds to the ratings on the unit's nameplates and that correctly rated electrical protection is provided.

Quick disconnect must be provided for this unit by the installer.

If additional refrigerant should be needed, be certain to use the correct type.

Make certain that adequate drainage is provided;

Be certain that the remote condensing unit is positioned within the range indicated on page 8 (CONNECTION TO THE REMOTE UNIT) in this manual and that it is connected as specified and in accordance with all applicable electrical codes.

INSTALLATION

ALL MODELS HAVE REMOTE CONDENSING UNITS. The condensing unit and the cabinet **must** be connected and installed in accordance with the following instructions:

LOCATION

Ambient air temperature for air cooled condensing units should be **no greater than 90°F** to ensure the rated performance. A remote condensing unit must be located away from direct sunlight if installed outdoors, or, if it is indoors, a water cooled condensing unit should be used.

DIMENSIONS

MODEL	LEFT - RIGHT	FRONT - BACK	HEIGHT	FRONT-BACK W/ DOOR OPEN
AP24BC250-3	54-3/8"	46-1/4"	86-5/8"	81"
AP24BCF300-3	54-3/8"	46-1/4"	86-5/8"	81"
AP40BC350-3	59"	50-1/8"	86-5/8"	85"
AP40BCF450-3	59"	50-1/8"	86-5/8"	85"

ELECTRICAL AND REFRIGERATION SPECIFICATIONS

MODEL	VOLTAGE	CABINET		REMOTE CONDENSER	
		AMPS	POWER SUPPLY CORD	BTU/H AT 14°F EVAP. TEMP. & 105°F COND. TEMP.	TYPE
AP24BC250-3	208/3/60	8	14-4	25,000	MEDIUM TEMP. -10°F/+40°F
AP24BCF300-3	208/3/60	8	14-4	50,000	MEDIUM/LOW TEMP. -40°F/+40°F
AP40BC350-3	208/3/60	10	14-4	35,000	MEDIUM TEMP. -10°F/+40°F
AP40BCF450-3	208/3/60	10	14-4	70,000	MEDIUM/LOW TEMP. -40°F/+40°F

NOTES:

1. The condensing unit and the cabinet must be connected to separate electrical power supplies.
2. Each wire must be connected to its corresponding terminal.
3. The ground wire must be connected to an efficient ground terminal.

CONNECTION TO THE REMOTE UNIT

The specified diameters (see chart on page 6) for the copper tubing used to connect the remote condensing unit to the cabinet are adequate **for a separation of up to 60 feet**. For greater distances, contact the factory for instructions.

NOTES:

1. The insulation used on the piping must be of high quality and must have closed cells.
2. Refer to pages 5 and 6 for connection drawings.
3. Quick disconnects **MUST** be mounted where shown.
4. Note the information regarding the installation of siphons (traps) when the cabinet and the remote condensing unit are at different levels. They are **NOT** needed when the condensing unit is at a lower level than the cabinet.

CONDENSATE DRAINAGE CONNECTION

It is important that the condensate from the evaporator is properly drained. The drain line from the evaporator exits from the rear of the cabinet. It must be connected in conformance with local regulations.

VERIFYING CORRECT INSTALLATION

- a. Check that there are no refrigerant leaks.
- b. Check that the refrigerant piping is insulated fully and correctly.
- c. Check that siphons (traps) have been installed.
- d. Check that the required quick disconnects have been installed.
- e. Check all electrical connections and that the power supply is of proper voltage (208 VAC +/- 5%, 3 ph., 60 Hz.).
- f. If the condensing unit is water cooled, check the connection to the water supply and the setting of the pressure valve.
- g. Check the provision for drainage of condensate water.
- h. If a unit has been transported in a non-vertical position (e.g. on its back) or if it has been overturned during installation, **WAIT AT LEAST TWELVE HOURS BEFORE TURNING IT ON**.
- i. If the condensing unit has been outside in cold temperatures, turn on the power to it for at least twelve hours before installation.
- j. Make sure that the refrigerant is Type 404A and adjust the expansion valve if necessary.
- k. Make sure that the fans of an air cooled condensing unit blow the air "UP".

- l. Make sure that the fans inside the cabinet rotate clockwise.
- m. Make sure that the cabinet has been leveled.

SPACES AROUND THE CABINET

- At least 15" clear space is required above the unit for service.
- At least 6" clear space is required on both sides of the cabinet.
- At least 6" clear space is required on the rear of the cabinet for drain hookup and maintenance.
- Enough space should be provided in front of the cabinet to fully open the door. The same space should be provided on the back of the cabinet for units with pass-thru doors.

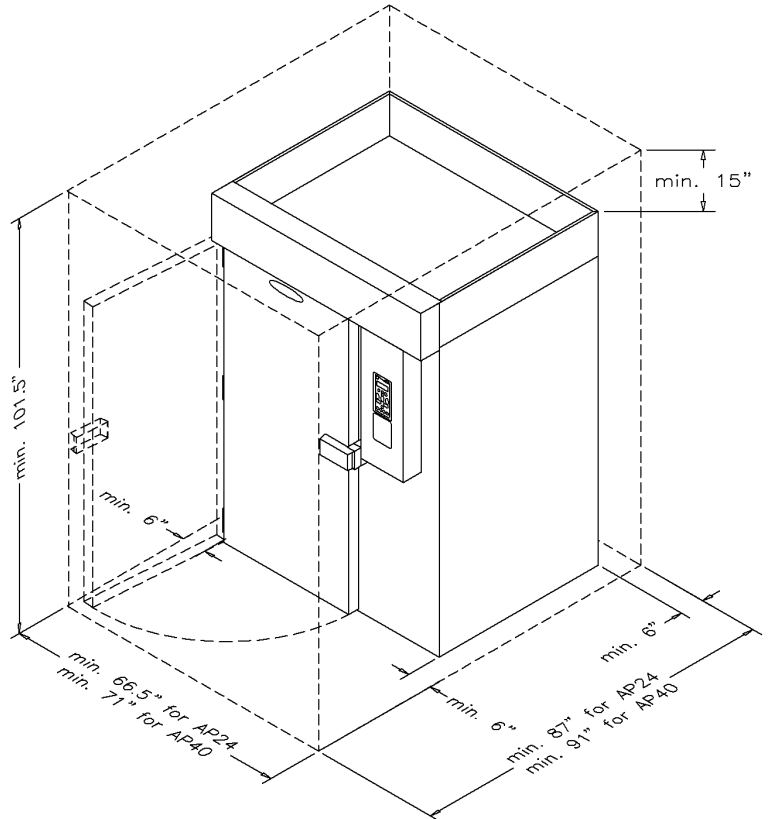

STARTING & TESTING THE UNIT

1. To charge the unit, use the "HARD" cycle and the "MANUAL" mode. Set for two hours of operation to allow enough time to fully charge the unit.

IMPORTANT: Immediately after starting the unit, check that the fans inside the cabinet are rotating CLOCKWISE, and that the fans in the condensing unit are rotating in accordance with the arrows on the blades. Improper rotation will damage the unit and void the warranty.

2. Start the unit per 1. above and in accordance with the following operating instructions, then perform at least one complete blast chilling or shock freezing cycle. When done, instruct the client on the correct use of the unit.

3. By the end of the cycle the unit should have pulled down to 0° F (AP24BCF300-3, AP40BCF450-3) or 10° F (AP24BC250-3, AP40BC350-3). It should have been cycling between 0° F and 10° F (AP24BCF300-3, AP40BCF450-3) or between 10° F and 20° F (AP24BC250-3, AP40BC350-3) and the sight glass must be clear.

4. As soon as possible after the unit has been started, check the power consumption, the standard pressure measurements and the operation of all the controls.

NOTE: The refrigerating system works on pressure. An electro valve mounted on the top of the cabinet is controlled by the electronic controller. When the temperature of the air in the cabinet falls to the programmed low temp setting, the electro valve will close (0 VAC) and the unit will pump down. When the temperature of the air in the cabinet rises to the programmed high temp setting, the electro valve will open and refrigeration will start.

USING THE HURRICHILL™ TECHNOLOGY

BLAST CHILLING

All cooked food rapidly loses its quality and aroma if it is not served promptly. Natural bacteria growth, the main reason why food becomes stale, takes place at an exponential rate between 140°F and 40°F. However lower temperatures have a hibernating effect that increases as the temperature drops, thereby gradually reducing bacterial activity until it stops altogether. Only fast reduction of the temperature at the product's core allows its initial characteristics to be maintained intact. The HurriChill™ blast chiller gets food through this high-risk temperature band rapidly, cooling the core of the product to 40°F within 90 minutes. This conserves food quality, color and aroma while increasing its storage life. After blast chilling, the food can be preserved at 38°F for up to 5 days.

SHOCK FREEZING

For storage over the medium-long term, food has to be shock frozen (to 0°F or below). Freezing means converting the water contained in food into crystals. Thanks to the high speed at which low temperature penetrates the food, the HurriChill™ shock freezer assures the formation of small crystals (micro-crystals) that do not damage the product in any way. Uncooked raw products, semi-processed foods and cooked foods can be treated safely. When the food is thawed, no liquids, consistency, weight or aroma will be lost, and all its initial qualities will remain unchanged.

SOFT CHILL CYCLE

(160°F to 40°F)

This cycle is recommended for "delicate", light, thin products or small piece sizes, such as vegetables, creams, sweets, fish products and fried foods. Soft chilling lowers the food temperature quickly, but extremely delicately so as not to damage the outside of the food. This is the ideal cycle to chill any food quickly but delicately, even in haute cuisine.

HARD CHILL CYCLE

(160°F TO 40°F)

Hard chilling is suited for "dense" products and products with a high fat content, in large pieces or those products typically more difficult to chill. Careful chilling control ensures that the end temperature of 40°F is reached at the core of the product, with no danger of freezing and damaging the product, not even on its surface.

SHOCK FREEZE CYCLE

(160°F TO 0°F)

This cycle is recommended when you want to store food for several weeks or months at temperatures below 0°F. Freezers are suited for storing ready frozen foods, but not for freezing them. During shock freezing, the liquids contained in the food are transformed into micro-crystals that do not harm the tissue structure. When the food is thawed, its quality will be excellent. It is especially suited for all semi-processed foods and raw products.

PANNING AND LOADING

PANNING

1. Standard pan depth is 2-1/2". Other depths can be used but are not recommended as their use would require an increase in the cycle time.
2. Stainless steel or aluminum pans are recommended, as plastic containers will increase the chilling time.
3. Crockery or stainless steel cylinders, 6" dia. and 10" max. height, are acceptable.
4. Slack filled Cryovac bags can be used if placed on wire shelves.
5. Most foods should be covered with stainless steel or aluminum lids, or with aluminum foil.
6. Foods should be left UNCOVERED in the following circumstances:
 - a. When a dry surface is desired, such as with fried chicken, fish or potatoes.
 - b. When the food has a relatively large surface, such as with chicken breasts, Salisbury steaks, etc.
 - c. For large roasts of beef, turkey, etc.
 - d. For pastry and other bakery products.
7. Some foods, such as roast beef, will continue to cook after removal from the oven. To avoid this, they should be chilled uncovered.
8. Food probes should be at the center of the food in the pan.
9. Always wipe the probe with an alcohol swab after removing it from the food then place the probe in the holding device.















LOADING

1. Place the pans on the mobile cart so that the pan ends will face the fans and the cold air will be drawn over the length of the pans.
2. The shelves should be loaded so that there is no less than 1 inch between the bottom of one pan and the top of the next. Also be certain that there is sufficient space between the top of any probe and the bottom of the pan above.
3. Place the loaded cart in the center of the chilling cabinet between the refrigeration coil and the fans.







**CONTROL PANEL FOR MODELS AP24 & AP40
BLAST CHILLERS / SHOCK FREEZERS**



KEYBOARD KEYS

<p>ON/OFF & START/STOP</p> <p> ON/OFF</p> <p> START/STOP</p>	<p>CYCLE KEYS</p> <p> SOFT CYCLE</p> <p> HARD CYCLE</p> <p> SHOCK CYCLE</p> <p> AUTOMATIC CYCLE</p> <p> MANUAL CYCLE</p> <p> UV LIGHT CYCLE</p> <p> DEFROST CYCLE</p> <p> PRINT</p> <p> HEAT PROBE CYCLE</p>
<p>PROGRAMMING KEYS</p> <p> UP</p> <p> DOWN</p> <p> SELECT</p> <p> ENTER</p>	



























KEY COMBINATIONS



- **Initial Programming** state – to initially set the device
 - With the display reading **"OFF"**, press and hold  (**"START/STOP"**) for 5 seconds
- **Cycles programming** state – to initially set the cycles
 - With the display reading **"OFF"**, press  (**"ENTER"**) for 1 second
- **Recipe name programming** state – to enter recipe names
 - With the display reading **"OFF"**, press  (**"A"**) for 10 seconds
- **Load default values** state – to load the standard parameters
 - With the display reading **"OFF"**, press  (**"UP"**) for 10 seconds
- **Clear events memory** state – to clear obsolete data
 - With the display reading **"OFF"**, press  +  (**"UP"+"DOWN"**) for 10 seconds
- **Ready To Go** state – in order to start a cycle
 - If the controller is not **"OFF"**, press  **"ON/OFF"** once.

PROGRAMMING

1. INITIAL PROGRAMMING



NOTE: Initial programming is preset at the factory. Use this section only if changes are desired. If no changes are to be made, skip to Page 17 (2. Programming the cycles).

<p>a. With the display reading "OFF", press  ("START/STOP") for a few seconds.</p>	<div style="border: 1px solid black; padding: 5px; text-align: center;">OFF</div>	
<p>b. To change the language, press  or  then press .</p>	<div style="border: 1px solid black; padding: 5px; text-align: center;">INITIAL PROGRAMMING SELECT LANGUAGE ENGLISH</div>	<div style="border: 1px solid black; padding: 2px; text-align: center;">ENGLISH Blinks</div>
<p>c. Enter the default password by pressing, in order, the    and  buttons.</p>	<div style="border: 1px solid black; padding: 5px; text-align: center;">INITIAL PROGRAMMING ENTER PASSWORD: ***</div>	
<p>If the entered password is wrong the display will show, for 3 seconds: Then the controller will go back to step c.</p>	<div style="border: 1px solid black; padding: 5px; text-align: center;">INITIAL PROGRAMMING WRONG PASSWORD TRY AGAIN</div>	<div style="border: 1px solid black; padding: 2px; text-align: center;">TRY AGAIN Blinks</div>
<p>NOTE: If a wrong password is introduced three times the controller will go into "OFF" state.</p>		
<p>During the password typing,  button can be used to delete one or more characters.</p>		
<p>d. If you do not wish to change the password, press .</p>	<div style="border: 1px solid black; padding: 5px; text-align: center;">INITIAL PROGRAMMING CHANGE PASSWORD? NO</div>	
<p>To change the default password, press  or  for "YES" then press .</p>		
<p>The password will always be a combination of three of the six available cycles:</p>		
<p>      ("SOFT", "HARD", "SHOCK", "DEF", "UV", "HEAT PROBE").</p>		
<p>Type the new password, then press . Be sure to remember the new password and keep a record of it in a safe place.</p>		
<p>e. To change the year, press  or  then press .</p>	<div style="border: 1px solid black; padding: 5px; text-align: center;">INITIAL PROGRAMMING SET YEAR 2006</div>	<div style="border: 1px solid black; padding: 2px; text-align: center;">2006(year) Blinks</div>
<p>f. To change the month, press  or  then press .</p>	<div style="border: 1px solid black; padding: 5px; text-align: center;">INITIAL PROGRAMMING SET MONTH 07</div>	<div style="border: 1px solid black; padding: 2px; text-align: center;">07(month) Blinks</div>

g. To set the day, press  or  then press  .



INITIAL PROGRAMMING
SET DAY 03

03(day)
Blinks

h. To set the hour, press  or  (be sure to continue to press the buttons until the hour and "AM" or "PM" show correctly) then press  .



INITIAL PROGRAMMING
SET TIME 10:25 AM

10(hours)
Blinks

i. To set the minutes, press  or  then press  .

INITIAL PROGRAMMING
SET TIME 10:25 AM



25(minutes)
Blinks

j. To change the number of probes, press  or  then press  .

INITIAL PROGRAMMING
AIR PROBES NUMBER? 1

1 Blinks



The high air alarm temperature should be left at 140 °F. However, if a change is desired:

k. To change the temperature, press  or  then press  .

INITIAL PROGRAMMING
HIGH AIR ALARM 140 °F

140 Blinks



The low air alarm temperature should be left at -35 °F *. However, if a change is desired:

l. To change the temperature, press  or  then press  .

INITIAL PROGRAMMING
LOW AIR ALARM -35 °F *

-35 Blinks

*- 35° F for shock freezers (AP24BCF300-3, AP40BCF450-3)
- 5° F for blast chillers (AP24BC250-3, AP40BC350-3)



m. To change the number of probes, press  or  then press  .

INITIAL PROGRAMMING
FOOD PROBES NUMBER? 1

1 Blinks

NOTE: Standard configuration has only one food probe. However, a maximum of 4 probes can be used with these models.



The high food alarm temperature should be left at 180 °F. However, to make a change:

n. To change the temperature, press  or  then press  .

INITIAL PROGRAMMING
HIGH FOOD ALARM 180 °F



180 Blinks

The low food alarm temperature should be left at 35 °F. However, to make a change:

o. To change the temperature, press  or  then press .

INITIAL PROGRAMMING
SOFT & HARD
LOW FOOD ALARM
35 °F



35 Blinks

p. To change to **YES** or **NO**, press  or  then press .

INITIAL PROGRAMMING
SHOCK FREEZE?
YES *



YES Blinks

* **YES** for shock freezers (AP24BCF300-3, AP40BCF450-3)
NO for blast chillers (AP24BC250-3, AP40BC350-3) and go to step r.

q. To change the temperature, press  or  then press .



INITIAL PROGRAMMING
SHOCK FREEZE
LOW FOOD ALARM
-5 °F

-5 Blinks

r. To change to **YES** or **NO**, press  or  then press .



INITIAL PROGRAMMING
UV CYCLE?
NO

NO Blinks

s. To change to **YES** or **NO**, press  or  then press .

INITIAL PROGRAMMING
DEFROST CYCLE?
YES



YES Blinks

t. To change to **YES** or **NO**, press  or  then press .

INITIAL PROGRAMMING
PC CONNECTION?
NO



NO Blinks

For **YES**, the display will show:
The P.C. baud rate should be left at 38400.
However, to make a change:

u. To change the baud rate, press  or  then press .



INITIAL PROGRAMMING
PC BAUDRATE
38400

38400 Blinks

v. To change the number (between 01 & 32), press  or  then press .

INITIAL PROGRAMMING
CHILLER NETWORK ID
01



01 Blinks

w. To change to **YES** or **NO**, press  or  then press .

INITIAL PROGRAMMING
PRINTER CONNECTION?
NO

NO Blinks

For **YES**, the display will show:
The printer baud rate should be left at 1200.
 However, to make a change:

x. To change the baud rate, press  or  then
 press  .



INITIAL PROGRAMMING PRINTER BAUDRATE 1200

 Blinks

y. To change the timing, press  or  then
 press  .



INITIAL PROGRAMMING PRINT & SAVE EVENTS EVERY 15 MIN
--

 Blinks

z. To change to **YES** or **NO**, press  or  then
 press  .



INITIAL PROGRAMMING PRINT DURING CYCLE NO

 Blinks

aa. To change to **YES** or **NO**, press  or  then
 press  .

INITIAL PROGRAMMING RECIPES? NO

 Blinks

bb. To change to **YES** or **NO**, press  or  then
 press  .

INITIAL PROGRAMMING NAFEM COMMUNICATION NO
--

 Blinks

The display will show for 2 seconds:
 Then the controller will go into “**OFF**” state.

INITIAL PROGRAMMING COMPLETE

NOTE: During programming  key can be used to return to the previous screen (except at the steps 1h, 1i and 3d, when it has different functions).

 key is used to confirm the settings and advance to the next screen.

At any time, to bring the controller to “**OFF**” state, just pres the  (“**ON/OFF**”) button.

2. PROGRAMMING THE CYCLES

a. With the display reading “**OFF**”, press  .

OFF

b. Enter the password (see page 14), then press  .



PARAM. PROGRAMMING ENTER PASSWORD ***

AUTOMATIC SOFT CYCLE PARAMETERS PROGRAMMING

The LED for "A" will be "ON".
The LED'S for cycles will be blinking.



PARAM. PROGRAMMING
AUTOMATIC MODE
CHOOSE
PROGRAMMING CYCLE

c. Press . The LED for "SOFT" will be steady "ON".

d. To change the temperature, press  or 
then press .



PARAM. PROGRAMMING
AUTOMATIC SOFT CYCLE
LOW AIR TEMPERATURE
28 °F

 Blinks

e. To change the temperature, press  or 
then press .



PARAM. PROGRAMMING
AUTOMATIC SOFT CYCLE
HIGH AIR TEMPERATURE
35 °F

 Blinks

f. To change the temperature, press  or 
then press .



PARAM. PROGRAMMING
AUTOMATIC SOFT CYCLE
FOOD TEMPERATURE
40 °F

 Blinks

g. To change the temperature, press  or 
then press .

PARAM. PROGRAMMING
AUTOMATIC SOFT CYCLE
HOLDING LOW TEMP.
35 °F

 Blinks

h. To change the temperature, press  or 
then press .

PARAM. PROGRAMMING
AUTOMATIC SOFT CYCLE
HOLDING HIGH TEMP.
42 °F

 Blinks

The display will show:

PARAM. PROGRAMMING
AUTOMATIC SOFT CYCLE
PROGRAMMING COMPLETE

AUTOMATIC HARD CYCLE PARAMETERS PROGRAMMING

After about 2 seconds the display will automatically change to:

The LED for "A" will be "ON".
The LED'S for cycles will be blinking.

PARAM. PROGRAMMING
AUTOMATIC MODE
CHOOSE
PROGRAMMING CYCLE

i. Press the  button. The LED for "HARD" will be steady "ON".



j. To change the temperature, press  or 

PARAM. PROGRAMMING
AUTOMATIC HARD CYCLE
LOW AIR TEMP PART 1
0 °F *

 Blinks

then press .



* 0° F for shock freezers (AP24BCF300-3, AP40BCF450-3)
10° F for blast chillers (AP24BC250-3, AP40BC350-3)

k. To change the temperature, press  or 
then press .

PARAM. PROGRAMMING
AUTOMATIC HARD CYCLE
HIGH AIR TEMP PART 1
10 °F **



 Blinks

** 10° F for shock freezers (AP24BCF300-3, AP40BCF450-3)
20° F for blast chillers (AP24BC250-3, AP40BC350-3)

l. To change the temperature, press  or 
then press .



PARAM. PROGRAMMING
AUTOMATIC HARD CYCLE
BREAKING TEMP
60 °F

 Blinks

m. To change the temperature, press  or 
then press .



PARAM. PROGRAMMING
AUTOMATIC HARD CYCLE
LOW AIR TEMP PART 2
28 °F

 Blinks

n. To change the temperature, press  or 
then press .



PARAM. PROGRAMMING
AUTOMATIC HARD CYCLE
HIGH AIR TEMP PART 2
35 °F

 Blinks

o. To change the temperature, press  or 
then press .



PARAM. PROGRAMMING
AUTOMATIC HARD CYCLE
HARD FOOD TEMP.
40 °F

 Blinks

p. To change the temperature, press  or 
then press .

PARAM. PROGRAMMING
AUTOMATIC HARD CYCLE
HOLDING LOW TEMP.
35 °F

 Blinks

q. To change the temperature, press  or 
then press .

PARAM. PROGRAMMING
AUTOMATIC HARD CYCLE
HOLDING HIGH TEMP.
42 °F

 Blinks

The display will show:



PARAM. PROGRAMMING
AUTOMATIC HARD CYCLE
PROGRAMMING COMPLETE

AUTOMATIC SHOCK CYCLE PARAMETERS PROGRAMMING

After about 2 seconds the display will automatically change to:
 The LED for "A" will be "ON".
 The LED'S for cycles will be blinking.



PARAM. PROGRAMMING
 AUTOMATIC MODE
 CHOOSE
 PROGRAMMING CYCLE

r. Press the  button (for shock freezers only).
 The LED for "SHOCK" will be steady "ON".

s. To change the temperature, press  or 
 then press .



PARAM. PROGRAMMING
 AUTOMATIC SHOCK CYCLE
 LOW AIR TEMPERATURE
 -25 °F

 Blinks

t. To change the temperature, press  or 
 then press .



PARAM. PROGRAMMING
 AUTOMATIC SHOCK CYCLE
 HIGH AIR TEMPERATURE
 -15 °F

 Blinks

u. To change the temperature, press  or 
 then press .



PARAM. PROGRAMMING
 AUTOMATIC SHOCK CYCLE
 FOOD TEMPERATURE
 0 °F

 Blinks

v. To change the temperature, press  or 
 then press .

PARAM. PROGRAMMING
 AUTOMATIC SHOCK CYCLE
 HOLDING LOW TEMP
 -4 °F

 Blinks

w. To change the temperature, press  or 
 then press .

PARAM. PROGRAMMING
 AUTOMATIC SHOCK CYCLE
 HOLDING HIGH TEMP
 3 °F

 Blinks

The display will show:

PARAM. PROGRAMMING
 AUTO SHOCK CYCLE
 PROGRAMMING COMPLETE

UV LIGHT CYCLE PARAMETERS PROGRAMMING

After about 2 seconds the display will automatically change to:
 The LED for "A" will be "ON".
 The LED'S for cycles will be blinking.

PARAM. PROGRAMMING
 AUTOMATIC MODE
 CHOOSE
 PROGRAMMING CYCLE

x. Press the  button. The LED for "UV LIGHT" will be steady "ON".

y. To change the time, press  or  then press  .

PARAM. PROGRAMMING
UV CYCLE
CYCLE TIME
H 00:30 MIN

00:30 Blinks

The display will show:

PARAM. PROGRAMMING
UV CYCLE
PROGRAMMING COMPLETE

DEFROST CYCLE PARAMETERS PROGRAMMING

After about 2 seconds the display will automatically change to:
The **LED** for "A" will be "ON".
The **LED'S** for cycles will be blinking.

PARAM. PROGRAMMING
AUTOMATIC MODE
CHOOSE
PROGRAMMING CYCLE



z. Press the  button. The **LED** for "DEFROST" will be steady "ON".

The defrost type must be left AIR FLOW.

aa. Press  .

PARAM. PROGRAMMING
DEFROST CYCLE
CHOOSE TYPE
AIR FLOW

AIR FLOW
Blinks

bb. To change the time, press  or  then press  .

PARAM. PROGRAMMING
DEFROST CYCLE
TOTAL TIME
05 MIN

05 Blinks

The display will show:

PARAM. PROGRAMMING
DEFROST CYCLE
PROGRAMMING COMPLETE



NOTE: The defrost is done by running the evaporator fan for 5 minutes with the door open.

HEATED PROBE CYCLE PARAMETERS PROGRAMMING

After about 2 seconds the display will automatically change to:
The **LED** for "A" will be "ON".
The **LED'S** for cycles will be blinking.

PARAM. PROGRAMMING
AUTOMATIC MODE
CHOOSE
PROGRAMMING CYCLE

cc. Press the  button. The **LED** for "HEATED PROBE" will be steady "ON".

dd. To change the temperature, press  or  then press  .

PARAM. PROGRAMMING
HEATED PROBE CYCLE
HEATING TEMPERATURE
30 °F

30 Blinks

ee. To change the time, press  or  then press  .

PARAM. PROGRAMMING
HEATED PROBE CYCLE
HEATING TIME
05 SEC

 Blinks

The display will show:

PARAM. PROGRAMMING
HEATED PROBE CYCLE
PROGRAMMING COMPLETE

After about 2 seconds the display will automatically change to:
The LED for "A" will be "ON".
The LED'S for cycles will be blinking.



PARAM. PROGRAMMING
AUTOMATIC MODE
CHOOSE
PROGRAMMING CYCLE

ff. Press  to program the manual mode. The "M" LED will be steady "ON" and the 6 "CYCLE LED's" will all blink.

MANUAL SOFT CYCLE PARAMETERS PROGRAMMING



gg. Press  . The LED for "SOFT" will be steady "ON".

PARAM. PROGRAMMING
MANUAL MODE
CHOOSE
PROGRAMMING CYCLE

hh. To change the temperature, press  or  then press  .



PARAM. PROGRAMMING
MANUAL SOFT CYCLE
LOW AIR TEMPERATURE
28 °F

 Blinks

ii. To change the temperature, press  or  then press  .



PARAM. PROGRAMMING
MANUAL SOFT CYCLE
HIGH AIR TEMPERATURE
35 °F

 Blinks

jj. To change the time, press  or  then press  .



PARAM. PROGRAMMING
MANUAL SOFT CYCLE
TOTAL TIME
H 01:30 MIN

 Blinks

kk. To change the temperature, press  or  then press  .

PARAM. PROGRAMMING
MANUAL SOFT CYCLE
HOLDING LOW TEMP
35 °F

 Blinks

ll. To change the temperature, press  or  then press  .

PARAM. PROGRAMMING
MANUAL SOFT CYCLE
HOLDING HIGH TEMP
42 °F

 Blinks

The display will show:



PARAM. PROGRAMMING
MANUAL SOFT CYCLE
PROGRAMMING COMPLETE

MANUAL HARD CYCLE PARAMETERS PROGRAMMING

After about 2 seconds the display will automatically change to:
The LED for "M" will be "ON".
The LED'S for cycles will be blinking.

PARAM. PROGRAMMING
MANUAL MODE
CHOOSE
PROGRAMMING CYCLE



mm. Press the  button. The LED for "HARD" will be steady "ON".

nn. To change the temperature, press  or 
then press .

PARAM. PROGRAMMING
MANUAL HARD CYCLE
LOW AIR TEMP PART 1
0 °F *

 Blinks



* 0° F for shock freezers (AP24BCF300-3, AP40BCF450-3)
10° F for blast chillers (AP24BC250-3, AP40BC350-3)

oo. To change the temperature, press  or 
then press .

PARAM. PROGRAMMING
MANUAL HARD CYCLE
HIGH AIR TEMP PART 1
10 °F **



 Blinks

** 10° F for shock freezers (AP24BCF300-3, AP40BCF450-3)
20° F for blast chillers (AP24BC250-3, AP40BC350-3)

pp. To change the time, press  or 
then press .



PARAM. PROGRAMMING
MANUAL HARD CYCLE
TIME 1
H 01:00 MIN

 Blinks

qq. To change the temperature, press  or 
then press .



PARAM. PROGRAMMING
MANUAL HARD CYCLE
LOW AIR TEMP PART 2
28 °F

 Blinks

rr. To change the temperature, press  or 
then press .







PARAM. PROGRAMMING
MANUAL HARD CYCLE
HIGH AIR TEMP PART 2
35 °F

 Blinks

















ss. To change the time, press  or 
then press .

PARAM. PROGRAMMING
MANUAL HARD CYCLE
TIME 2
H 01:00 MIN

 Blinks

<p>tt. To change the temperature, press  or  then press  .</p>	<p>PARAM. PROGRAMMING MANUAL HARD CYCLE HOLDING LOW TEMP. 35 °F</p>	<p>35 Blinks</p>
<p>uu. To change the temperature, press  or  then press  .</p>	<p>PARAM. PROGRAMMING MANUAL HARD CYCLE HOLDING HIGH TEMP. 42 °F</p>	<p>42 Blinks</p>
<p>The display will show:</p>		<p>PARAM. PROGRAMMING MANUAL HARD CYCLE PROGRAMMING COMPLETE</p>

MANUAL SHOCK CYCLE PARAMETERS PROGRAMMING

<p>After about 2 seconds the display will automatically change to: The LED for "M" will be "ON". The LED'S for cycles will be blinking.</p>		<p>PARAM. PROGRAMMING MANUAL MODE CHOOSE PROGRAMMING CYCLE</p>
<p>vv. Press the  button (for shock freezers only). The LED for "SHOCK" will be steady "ON".</p>		
<p>ww. To change the temperature, press  or  then press  .</p>	<p>PARAM. PROGRAMMING MANUAL SHOCK CYCLE LOW AIR TEMPERATURE -25 °F</p>	<p>-25 Blinks</p>
<p>xx. To change the temperature, press  or  then press  .</p>	<p>PARAM. PROGRAMMING MANUAL SHOCK CYCLE HIGH AIR TEMPERATURE -15 °F</p>	<p>-15 Blinks</p>
<p>yy. To change the time, press  or  then press  .</p>	<p>PARAM. PROGRAMMING MANUAL SHOCK CYCLE TOTAL TIME H 04:00 MIN</p>	<p>04:00 Blinks</p>
<p>zz. To change the temperature, press  or  then press  .</p>	<p>PARAM. PROGRAMMING MANUAL SHOCK CYCLE HOLDING LOW TEMP. -4 °F</p>	<p>-4 Blinks</p>
<p>aaa. To change the temperature, press  or  then press  .</p>	<p>PARAM. PROGRAMMING MANUAL SHOCK CYCLE HOLDING HIGH TEMP. 3 °F</p>	<p>3 Blinks</p>

The display will show:

PARAM. PROGRAMMING
MANUAL SHOCK CYCLE
PROGRAMMING COMPLETE

After about 2 seconds the display will automatically change to:

PARAM. PROGRAMMING
MANUAL MODE
CHOOSE
PROGRAMMING CYCLE

NOTE: PROGRAMMING FOR "DEFROST", "UV" & "HEAT PROBE" WILL BE THE SAME IN MANUAL MODE AS IT IS IN AUTOMATIC MODE (see pages 20-22).

3. RECIPE NAME PROGRAMMING



a. With the display reading **"OFF"**, press the  button and hold it for 10 seconds.

OFF

b. Enter your password (see page 14), then press





RECIPES PROGRAMMING
ENTER PASSWORD

c. Press  or  to change to the desired recipe number (from 1 to 150), then press  which will move you to the **"NAME"** line.

ENTER RECIPE NUMBER
1
ENTER RECIPE NAME

 Blinks

d. Using  or  type the letters or numbers required, then press . To confirm the recipe

ENTER RECIPE NUMBER
1
ENTER RECIPE NAME
CHICKEN_

 Blinks

and go to the next one press .

If a mistake is made in writing a recipe, use  to go to

the desired location and correct it using  or



















. There is a blank space after number 9. It can be

used to add a space or delete a letter. Press  when the recipe is corrected.

To finish the recipe name programming press  ("ON/OFF").

OPERATION

1. AUTOMATIC MODE - SOFT CHILL

<p>a. With the display reading "OFF", press the  ("ON/OFF") button.</p>	<p>OFF</p>	
<p>b. To select the soft cycle, press the appropriate button . The LED for "SOFT" will be steady "ON".</p>	<p>OPERATING MODE CHOOSE OPERATING CYCLE</p>	
<p>c. The LED's for "AUTOMATIC" and "MANUAL" are now blinking. To select an "AUTOMATIC" cycle, press the button . The LED for "AUTOMATIC" will now be steady "ON".</p>	<p>SOFT CYCLE CHOOSE MODE AUTO / MAN</p>	
<p>d. To choose your recipe, press  or  then press .</p>	<p>RED FOOD PROBE ENTER RECIPE NUMBER 1 CHICKEN</p>	<p> Blinks</p>
<p>e. To choose your recipe, press  or  then press .</p>	<p>YELLOW FOOD PROBE ENTER RECIPE NUMBER 2 ROAST BEEF</p>	<p> Blinks</p>
<p>f. To choose your recipe, press  or  then press .</p>	<p>BLUE FOOD PROBE ENTER RECIPE NUMBER 1 CHICKEN</p>	<p> Blinks</p>
<p>g. To choose your recipe, press  or  then press .</p>	<p>GREEN FOOD PROBE ENTER RECIPE NUMBER 2 ROAST BEEF</p>	<p> Blinks</p>

NOTE:

This screen is shown only if the **RECIPE** parameter is set to "ON" in the **INITIAL PROGRAMMING**. A 4 food probe configuration is shown. The red food probe **only** will be active in the standard configuration. To enter additional recipe names, refer to Page 25 "**RECIPE NAME PROGRAMMING**".

The display will show:

alternating with

READY TO START
PRESS START

**PRESS
START**
Blinks

alternating with

03.07.2006	10:28 AM
AIR 1	75°F
00:00	

h. Press the  ("**START/STOP**") button to start the cycle.

R / CHICKEN	140°F
Y / ROAST BEEF	143°F
B / CHICKEN	141°F
G / ROAST BEEF	142°F

The display will show briefly:

STARTING CYCLE . . .

Then the display will show:

alternating with

03.07.2006	10:28 AM
AIR 1	75°F
00:00	

00:00
Will count up

R / CHICKEN	140°F
Y / ROAST BEEF	143°F
B / CHICKEN	141°F
G / ROAST BEEF	142°F

The **AUTOMATIC** mode uses both the food probes and air probe temperatures to control the cycle. When all the food temperatures have reached the final setting of 40° F, the unit will automatically go into holding mode and a beep will sound for 5 seconds. The elapsed time and food temperature readouts will blink.

The display will show:

alternating with

03.07.2006	11:57 AM
AIR 1	34°F
01:29	

01:29 Blinks

R / CHICKEN	40°F
Y / ROAST BEEF	40°F
B / CHICKEN	40°F
G / ROAST BEEF	40°F

40°F
is alternating
with
Ready

The operator can now end this cycle by pressing the  ("**START/ STOP**") button.

The display will show briefly:

STOPPING CYCLE . . .

Then the display will show:

OPERATING MODE
CHOOSE OPERATING CYCLE

2. MANUAL MODE - SOFT CHILL

F INSTEAD OF AUTOMATIC you wish to select a **MANUAL** cycle, perform steps 1.a, 1.b, 1.c, 1.d, 1.e, 1.f and 1.g (above), except in step 1.c press button **M** instead of button **A**. The LED for **"MANUAL"** will then be steady **"ON"**. The readouts in those steps will be the same as before.

NOTE: Cycle time can be changed only in Cycle Programming mode. To change the programmed cycle time for any cycle see the instructions on Pages 17 to 25.

h. Press the  ("**START/STOP**") button to start the cycle.

The display will show briefly:

STARTING CYCLE . . .

Then the display will show:

alternating with

03.07.2006	10:41 AM
AIR 1	75°F
01:29	

01:29
Will count down

R / CHICKEN	140°F
Y / ROAST BEEF	143°F
B / CHICKEN	141°F
G / ROAST BEEF	142°F

The **MANUAL** mode uses time and the air probe temperature to control the cycle. The default total time for a soft cycle is 90 minutes. After the 90 minutes the unit will automatically go into holding mode.

The display will show:

alternating with

03.07.2006	10:41 AM
AIR 1	34°F
00:00	

00:00 Blinks

R / CHICKEN	40°F
Y / ROAST BEEF	40°F
B / CHICKEN	40°F
G / ROAST BEEF	40°F

The operator can now end this cycle by pressing  ("**START/ STOP**").

The display will show briefly:

STOPPING CYCLE . . .

Then the display will show:

OPERATING MODE
CHOOSE
OPERATING CYCLE

3. HARD CHILL CYCLE

To perform a hard chill cycle, follow steps **1 or 2** (above), **EXCEPT** in step 1.b (above) press

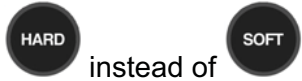

4. SHOCK FREEZE CYCLE

To perform a shock freeze cycle, follow steps **1 or 2** (above), **EXCEPT** in step 1.b (above) press

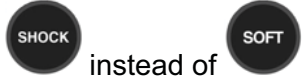

5. UV (STERILIZATION) CYCLE

a. To perform a UV cycle **remove all food**, then press

the  ("UV LIGHT") button.

OPERATING MODE CHOOSE OPERATING CYCLE

b. Press the  ("START/STOP") button to start the UV cycle.

03.07.2006 11:43 AM UV CYCLE READY TO START
--

READY TO START
Blinks

The display will show briefly:

STARTING CYCLE . . .

Then the display will now show:

03.07.2006 11:43 AM UV CYCLE UV TIME 29:59
--

29:59
Will count down to 00:00

After 30 minutes the display will show:
The controller will beep for a few seconds.

03.07.2006 12:13 PM UV CYCLE COMPLETE
--

COMPLETE
Blinks

The operator can now end this cycle by pressing  ("START/ STOP").

The display will show briefly:

STOPPING CYCLE . . .

Then the display will show:

OPERATING MODE CHOOSE OPERATING CYCLE

6. DEFROST CYCLE

The defrost cycle runs the evaporator fan for 5 minutes with the door open.



a. To perform a defrost cycle, press the ("**DEFROST**") button.

OPERATING MODE
CHOOSE
OPERATING CYCLE

b. Open the door.

03.07.2006 12:15 PM
DEFROST CYCLE
OPEN THE DOOR!

c. Press the  ("**START/STOP**") button to start the defrost cycle.

03.07.2006 12:15 PM
DEFROST CYCLE
READY TO START

**READY TO
START**
Blinks

The display will show briefly:

STARTING CYCLE . . .

Then the display will now show:

03.07.2006 12:15 PM
DEFROST CYCLE
DEFROST TIME 04:59

04:59
Will count
down to
00:00

After 5 minutes the display will show:
The controller will beep for a few seconds.

03.07.2006 12:20 PM
DEFROST CYCLE
COMPLETE

COMPLETE
Blinks

The operator can now end this cycle by pressing  ("**START/ STOP**").





The display will show briefly:

STOPPING CYCLE . . .



Then the display will show:

OPERATING MODE
CHOOSE
OPERATING CYCLE





7. HEATED FOOD PROBE

<p>a. To select the heated food probe, press  ("HEATED PROBE").</p>	<p>OPERATING MODE CHOOSE OPERATING CYCLE</p>	
<p>If the food probe temperature is over 30°F, the display will show:</p> <p>After a few seconds it will go back to reading:</p>	<p>HEATED FOOD PROBE NOT NEEDED</p>	
<p>If the food probe temperature is less than 30°F, the display will show:</p> <p>b. Open the door.</p>	<p>OPERATING MODE CHOOSE OPERATING CYCLE</p>	
<p>c. Press the  ("START/STOP") button to start the cycle.</p>	<p>HEAT FOOD PROBE READY TO START</p>	<p>READY TO START Blinks</p>
<p>The display will now show:</p> <p>After 5 seconds the display will show:</p>	<p>HEATING FOOD PROBES</p>	
<p>JTE: To stop any cycle before it has finished, press  ("START/STOP"). The controller will beep for a few seconds. If you still want to stop the cycle, press  ("START/STOP") again. If you do NOT want to stop, do nothing and the cycle will continue.</p>	<p>HEATING COMPLETE EXTRACT THE PROBES</p>	<p>HEATING COMPLET E Blinks</p>
	<p>UNIT IN PROCESS DO YOU WANT TO STOP?</p>	

8. PREPARING AND USING THE OPTIONAL PRINTER

<p>a. With the display reading "OFF", press the  ("PRINT") button.</p>	<p>OFF</p>
<p>b. To start printing, press the  ("START/STOP") button.</p>	<p>PRINT EVENTS MEMORY READINGS LEFT 249</p>
<p>After a few seconds the display will show: and the printer will be printing.</p>	<p>PRINT EVENTS MEMORY PRINTING ...</p>

9. TO CLEAR DATA

<p>a. To clear existing data that is no longer needed from the controller, from the "OFF" display, press  and  together for about 10 seconds.</p>	<p>OFF</p>
<p>b. Press .</p>	<p>CLEAR EVENTS MEMORY? NO NO Blinks</p>
<p>c. Press .</p>	<p>CLEAR EVENTS MEMORY? YES YES Blinks</p>
<p>d. Enter your password, then press .</p>	<p>CLEAR EVENTS MEMORY? ENTER PASSWORD ***</p>
<p>e. Wait about 40 seconds,</p>	<p>CLEAR EVENTS MEMORY? PLEASE WAIT ...</p>
<p>After which the display will show, for only 2 seconds:</p>	<p>CLEAR EVENTS MEMORY? COMPLETE</p>

The display will go back to **"OFF"** and all 257 reading spaces will be available.

PRINTER

NOTE: The optional printer is delivered fully installed

LOADING A ROLL OF PAPER

1. Remove the paper cover by pressing on the groove patterns to pop the front edge up. Lift off the cover.
2. Press the rocker switch to the left. The light will go off.
3. Unroll several inches of paper.
4. Cut a straight edge on the paper roll if it is jagged. This will facilitate the entry of the paper into the printer.
5. Slide the paper (with the roll above the paper) through the slot connecting the paper compartment and the printer compartment. It can be slid in about 1/4" before it stops.
6. While holding the paper in place, press the rocker switch to the Paper Feed position and hold it there. The printer will activate and a rubber roller will pull the paper into the printer compartment. Release the switch when an inch of paper has emerged from the top of the printer.
7. Slide the paper through the slot in the printer cover.
8. Push the back of the printer cover down and into place.
9. Press the front of the printer cover down to lock in place.
10. Put the paper spindle into the paper roll and place the roll with the spindle onto the snaps near the back of the printer. Turn the paper roll to take up any slack. Make sure the roll of paper turns freely. If it does not turn freely, the paper will jam and can possibly damage the print mechanism.

REMOVING A ROLL OF PAPER

1. Using the Paper Feed Switch, advance the paper about one inch beyond the paper cutter.
2. Lift the paper roll away from the printer housing and cut the paper feeding to the printer with scissors. Try to make the cut as square as possible to help the next time you reload the paper.
3. Pull the remaining paper through the printer mechanism. Be sure to pull the paper from the top (paper cutter side).

WARNING: Pulling the paper out from the back of the printer will damage the print mechanism.

OPERATING THE PRINTER

The Paper Feed switch on the printer is a rocker type switch. Push the left side of the rocker switch to toggle the printer ON or OFF. A red light will go on when the printer switch is ON. Push the right side of the switch to advance the paper.

MAINTENANCE

When printing becomes difficult to see, replace the ribbon in your printer with an Epson HX-20 cartridge ribbon.

If your printer is used infrequently, the print impression may become weak because the ribbon dried out. In that case, advance the ribbon to a new section by holding down the Paper Feed switch for several seconds.

REPLACING THE RIBBON (NO PAPER IN THE PRINTER)

1. Turn the printer OFF.

2. Four small grooves are embossed on each side of the printer cover. Push down on one or both of these areas until the printer cover tilts up, then lift the cover completely off.
3. Push down on the right side of the ribbon cartridge where it is marked "PUSH". Remove the cartridge.
4. Install the new cartridge. Be sure the cartridge is inserted firmly to prevent weak or irregular printing. The cartridge must be properly seated and aligned for best printing
5. Turn the cartridge "knob" (marked by an arrow) clockwise to take up slack.
6. Replace the cover.
7. Replace the paper.

REPLACING THE RIBBON (WITH PAPER IN THE PRINTER)

1. It is possible to insert the ribbon cartridge if there is already paper in the printer.
2. Hold the cartridge at each end with thumb and forefinger and slide it over the paper and into the printer compartment.

Be sure the paper goes between the ribbon cartridge and the ink ribbon. If you get ribbon ink on the printer case, wipe it off immediately as once it dries it is difficult to remove.

MAINTENANCE AND CLEANING

CLEANING THE CONDENSER

For correct and efficient operation of the blast chiller, it is necessary that the condenser be kept clean so that air can circulate around it freely and come into contact with the whole of its surface.

This operation (to be performed every 30 days, max.) can be accomplished using a brush (non-metallic) to remove all the dust and dirt from the condenser fins. Remove the finned grid to gain access to the condenser.

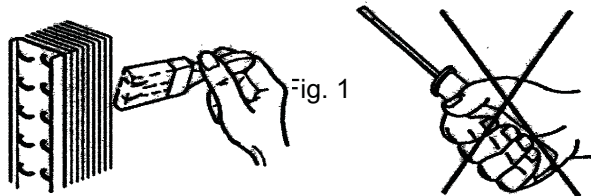

CLEANING COMPARTMENT

THE STORAGE

Clean the inside of the storage compartment daily to avoid altering the taste and aroma of the food.

Clean the inside, the grid supports and the grids with a non-corrosive detergent and then rinse thoroughly.

The storage compartment and its internal components have been designed to aid all cleaning operations.

Clean the outside surfaces regularly with a detergent for stainless steel and dry using a soft cloth.

Always defrost the unit (see manual).

DO NOT USE ABRASIVES, SOLVENTS OR GLASS WOOL (Fig. 3).

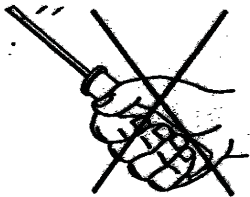

Fig.2

Avoid using sharp implements and abrasives, especially when cleaning the evaporator (Fig. 2).

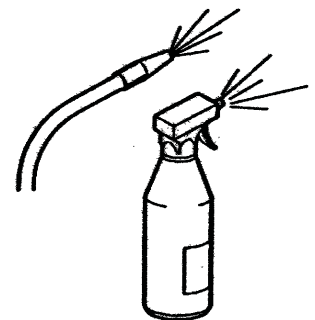
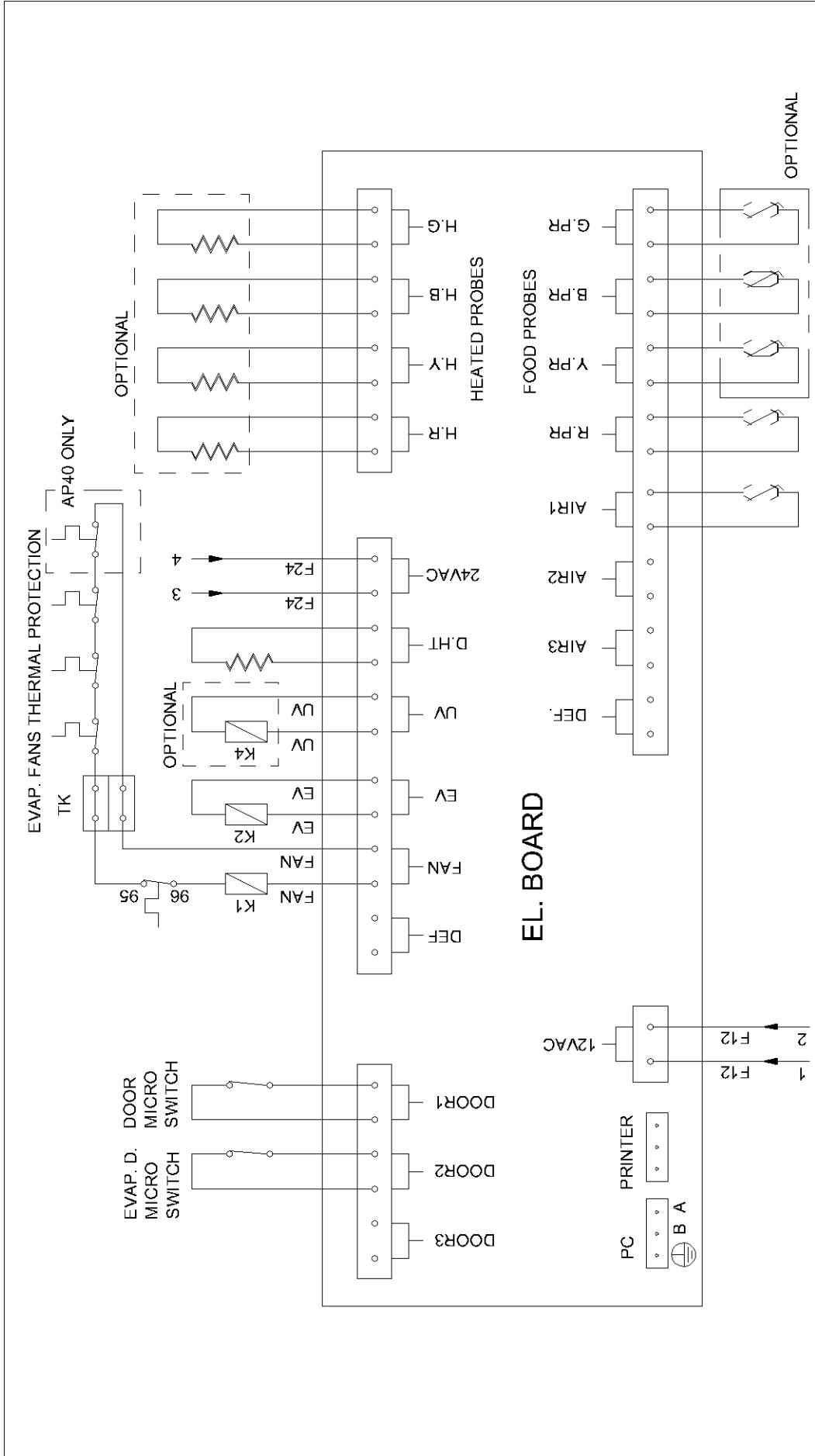

Fig. 3

NOTE: If additional refrigerant should be needed, be certain to use the correct type and amount as shown on the nameplate.

WIRING DIAGRAMS



REV.	DATE	DESCRIPTION	REV. BY	APP. BY

American Panel	
AMERICAN PANEL CORPORATION 5800 S.E. 78th St. Ocala, Florida 34472 Ph. (352) 245-7055 Fax (352) 245-0726	
TITLE: WIRING DIAGRAM #1	
MODEL: AP24BC(F)250(300)-3/AP40BC(F)350(450)-3	REV: A
DATE: 12/04/06	P.O.#:
DRAWN BY: GC	JOB#:
SCALE: NTS	DWG#: 98012-00+
SHEET: 1 of 1	SHEET: 1 of 1

This drawing and information contained herein are the exclusive property of American Panel Corporation. It shall be returned to American Panel Corporation upon demand and shall not be reproduced in whole or part, disclosed to anyone else, or used without the written consent of American Panel Corporation.

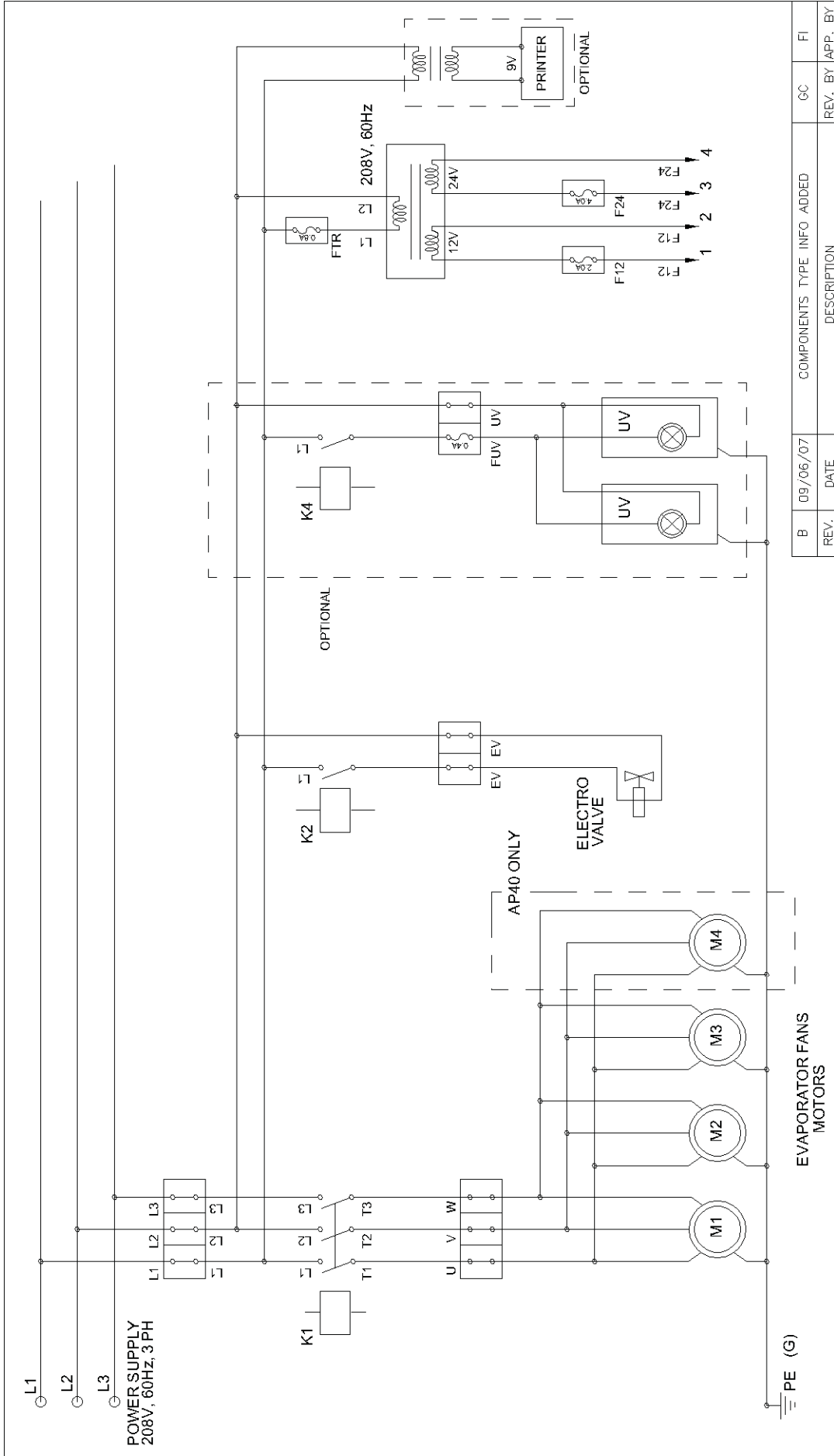

REV.	DATE	COMPONENTS	TYPE	INFO	ADDED	GC	FI
B	09/06/07						
DESCRIPTION							
AMERICAN PANEL CORPORATION 5800 S.E. 78th St. Ocala, Florida 34472 Ph. (352) 245-7055 Fax (352) 245-0726							
TITLE: WIRING DIAGRAM #2							
MODEL: AP24BC(F)250(300)-3/AP40BC(F)350(450)-3							
DATE:	12/04/06	DRAWN BY:	GC	P.O.#:		REV	B
SCALE:	NTS	DWG#:	98012-01+	JOB#:		SHEET	1 of 1

This drawing and information contained herein are the exclusive property of American Panel Corporation. It shall be returned to American Panel Corporation upon demand and shall not be reproduced in whole or part, disclosed to anyone else, or used without the written consent of American Panel Corporation.

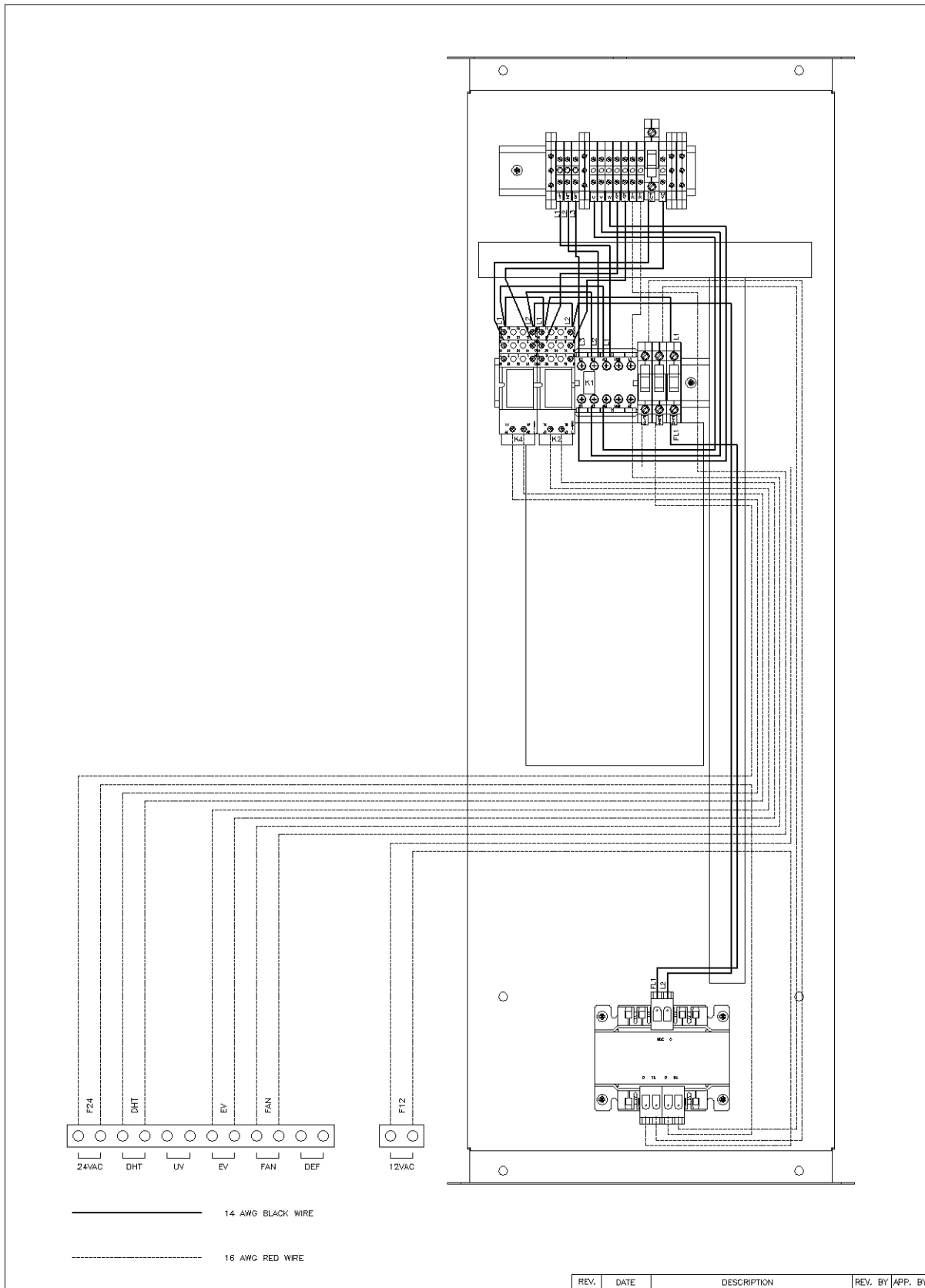

————— 14 AWG BLACK WIRE
 - - - - - 16 AWG RED WIRE

This drawing and information contained herein are the exclusive property of American Panel Corporation. It shall be returned to American Panel Corporation upon demand and shall not be reproduced in whole or part, disclosed to anyone else, or used without the written consent of American Panel Corporation.

REV.	DATE	DESCRIPTION	REV. BY	APP. BY
				
TITLE: WIRING DIAGRAM #3 MODEL: AP24BC(F)250(300)-3/AP40BC(F)350(450)-3 DATE: 05/22/06 SCALE: NTS DRAWN BY: GC DWG#: 98012-02 P.O.#: JOB#:				
			REV. A	
			SHEET 1 of 1	

COMPUTER CONNECTION

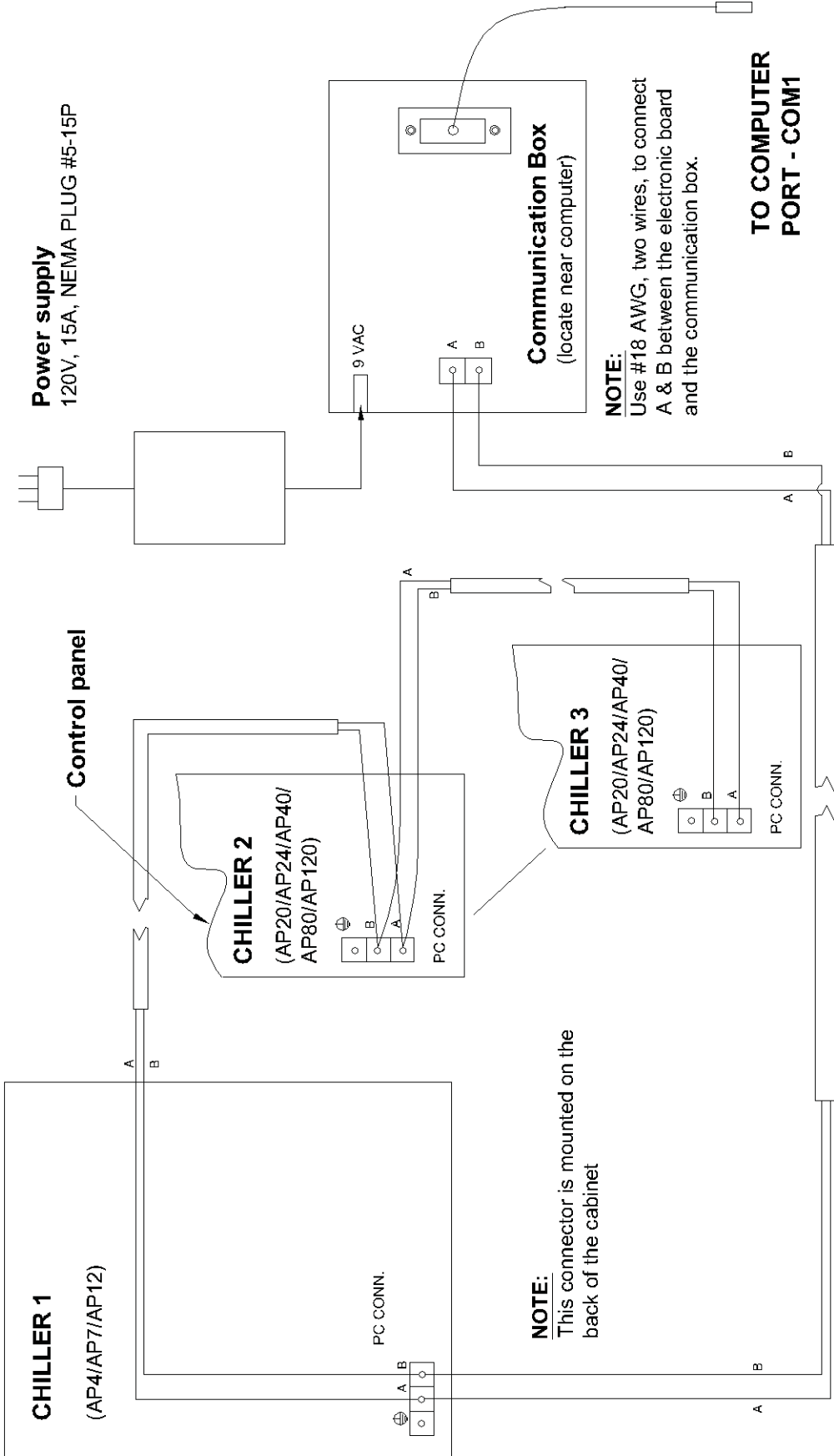

REV.	DATE	DESCRIPTION	REV. BY	APP. BY

American Panel		AMERICAN PANEL CORPORATION 5800 S.E. 78th St. Ocala, Florida 34472 Ph. (352) 245-7055 Fax (352) 245-0726	
TITLE: COMPUTER CONNECTION			
MODEL: AP4/AP7/AP12/AP20/AP24/AP40/AP80/AP120			
DATE:	DRAWN BY:	P.O.#:	REV:
06/02/06	GC		A
SCALE:	DWG#:	JOB#:	SHEET
NTS	98018-00		1 of 1

This drawing and information contained herein are the exclusive property of American Panel Corporation. It shall be returned to American Panel Corporation upon demand and shall not be reproduced in whole or part, disclosed to anyone else, or used without the written consent of American Panel Corporation.

PARTS LIST

PART #	DESCRIPTION
990059	PRINTER
990060	RELAY 10 A FINDER (UV)
990074	TRANSFORMER 208V/24V/12V
990075	TRANSFORMER FOR PRINTER
990103	ELECTRONIC BOARD "BLUE SYS" (D)
990104	PC CONNECTION BOX
990105	CONNECTION CABLE, SERIAL
990108	AIR PROBE PT100
990129	EVAPORATOR FANS CONTACTOR
990134	EVAPORATOR FAN
990137	FOOD PROBE – NON HEATED (BC MODELS)
990145	FOOD PROBE – HEATED (BCF MODELS)
990147	MAGNETIC DOOR SWITCH
990150	RELAY 10 A FINDER
990155	SOLENOID, DANFOSS
990156	SOLENOID SOCKET
990159	UV LAMP, 6W
990161	PRINTER POWER CABLE
990178	AC ADAPTOR PC CONNECTION
991014	BALL VALVE CASTEL B5
991025	EXPANSION VALVE TES2 AP24
991037	ORIFICE 01 AP40
991042	ORIFICE 02 AP24
991043	EVAPORATOR AP24
991044	EVAPORATOR AP40
991045	EXPANSION VALVE TES 5 AP40
991046	BALL VALVE CASTEL L02 AP40
991047	BALL VALVE CASTEL L04 AP24
991048	SOLENOID VALVE EVR 15
993018	DOOR GASKET 40T 33-3/4"X72-3/4"
993024	DOOR HINGE
993025	DOOR LOCK
993038	DOOR SWEEP

STANDARD WARRANTY

AMERICAN PANEL CORP.

5800 S.E. 78th Street, Ocala, Florida 34472-3412

American Panel Corporation products are warranted to the original user installed within the United States and Puerto Rico to be free from defects in materials and workmanship under normal use and service for the applicable period shown in the chart below.

NOTE: This Warranty does not apply to altered or misused parts.

BLAST CHILLERS / SHOCK FREEZERS (ONLY)

WARRANTY COVERS	PARTS	LABOR
Complete unit	1 year from date of shipment	1 year from date of shipment
COMPRESSOR ONLY	Additional 4 years	NONE
Food probes, UV and incandescent lamps	NONE	NONE

American Panel Corporation agrees to repair or replace at its option, FOB Factory, any part which proves to be defective due to defects in material or workmanship during the warranty period, providing the equipment has been properly installed, maintained and operated in accordance with the HurriChill™ User’s Manual. Refer to the above chart for details and exceptions for various equipment items. Labor covered by this warranty must be authorized by American Panel Corporation and performed by a factory-authorized service agency.

This warranty does not apply to remote or pre-assembled remote refrigeration systems requiring electrical inter-wiring or refrigerant piping provided by others. In no event shall American Panel Corporation be liable for the loss of use, revenue or profit or for any other indirect, incidental, special or consequential damages including, but not limited to, losses involving food spoilage or product loss. American Panel Corporation reserves the right to withdraw this warranty if it is determined that the equipment is not being operated properly. There are no other warranties expressed or implied.

During the warranty period, all requests for service **MUST** be made before any work is begun. Such requests must be directed to American Panel Corporation Service Department, which will issue written authorization when applicable. Without this authorization, the Warranty may be voided. The Service Department can be contacted by mail at American Panel Corp., 5800 S.E. 78th Street, Ocala, Florida 34472-3412; or by telephone at 1-800-327-3015; or by fax at (352) 245-0726.

Proper installation is the responsibility of the dealer, the owner-user, or the installing contractor. It is not covered by this Warranty.

ORDERING PRINTER SUPPLIES (RIBBON & PAPER)

Replacement paper and ribbons for the optional printer for your blast chiller can be ordered from a local distributor of Weigh-Tronix supplies.

To locate a distributor near you:

If you have access to the internet:

- Go to www.wtxweb.com
- Enter your zip code or city / state

If you do not have access to the internet:

- Call American Panel at 1-800-327-3015

Listing of Weigh-Tronix items and part numbers:

Weigh-Tronix Item Description	Weigh-Tronix Part Number
Paper (Roll)	22335-0018
Ribbon, Black	22332-0029