



REV. A

Cooler is Better!™



USER'S MANUAL

BLAST CHILLER / SHOCK FREEZER MODEL AP10BCF100-2

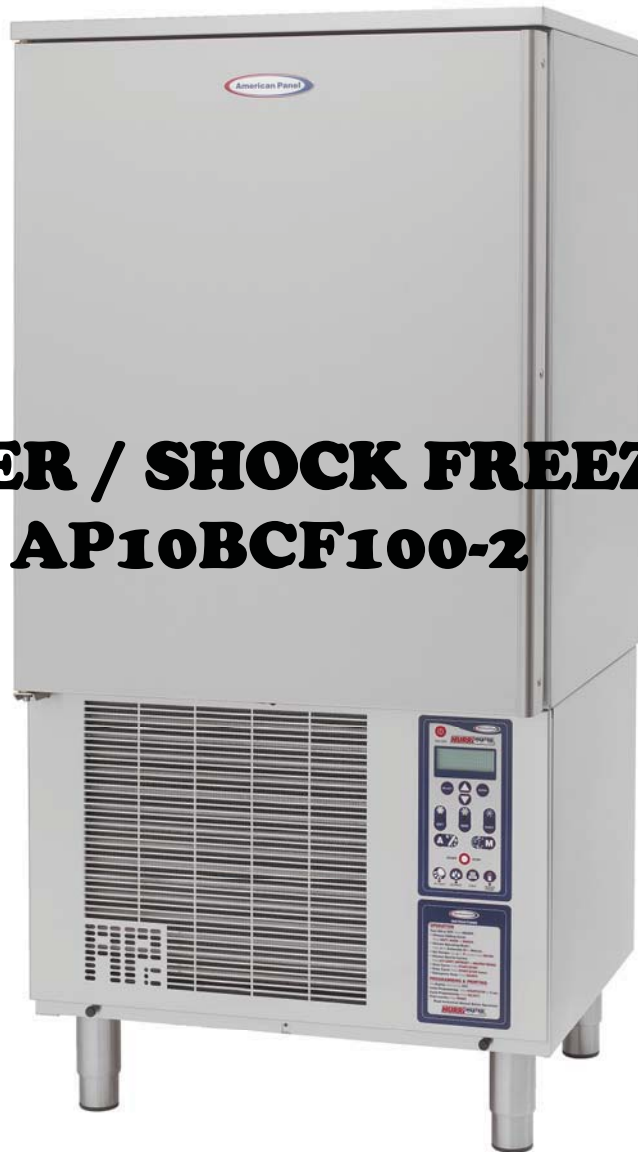

American Panel Corporation
5800 S.E. 78th Street, Ocala, Florida 34472-3412
Phone: (352) 245-7055 Fax: (352) 245-0726
E-mail: service@americanpanel.com

INDEX

INTRODUCTION	3
CONTROLLER FEATURES	3
OPERATING MODES	3
AUTOMATIC MODE	3
MANUAL MODE	3
OPERATING CYCLES	4
ADDITIONAL CYCLES	4
PRINTER (OPTIONAL)	4
PC CONNECTION (OPTIONAL)	4
INSTALLATION	4
WARNINGS	4
PREPARATION	4
INSTALLATION	5
DIMENSIONS	5
LOCATION	5
SPACES AROUND THE CABINET	5
USING THE HURRICHILL™ TECHNOLOGY	6
BLAST CHILLING	6
SHOCK FREEZING	6
SOFT CHILL CYCLE	6
HARD CHILL CYCLE	6
SHOCK FREEZE CYCLE	6
CONTROL PANEL FOR MODEL AP10BCF100-2 BLAST CHILLER	7
KEYBOARD KEYS	8
KEY COMBINATIONS	8
PROGRAMMING	9
1. INITIAL PROGRAMMING	9
2. PROGRAMMING THE CYCLES	12
AUTOMATIC SOFT CYCLE PARAMETERS PROGRAMMING	12
AUTOMATIC HARD CYCLE PARAMETERS PROGRAMMING	13
AUTOMATIC SHOCK CYCLE PARAMETERS PROGRAMMING	14
UV LIGHT CYCLE PARAMETERS PROGRAMMING	15
DEFROST CYCLE PARAMETERS PROGRAMMING	15
HEATED PROBE CYCLE PARAMETERS PROGRAMMING	16
MANUAL SOFT CYCLE PARAMETERS PROGRAMMING	16
MANUAL HARD CYCLE PARAMETERS PROGRAMMING	17
MANUAL SHOCK CYCLE PARAMETERS PROGRAMMING	18
3. RECIPE NAME PROGRAMMING	19
OPERATION	20
1. AUTOMATIC MODE - SOFT CHILL	20
2. MANUAL MODE - SOFT CHILL	21
3. HARD CHILL CYCLE	22
4. SHOCK FREEZE CYCLE	22
5. UV (STERILIZATION) CYCLE	22
6. DEFROST CYCLE	22

7. HEATED FOOD PROBE	23
8. PREPARING AND USING THE OPTIONAL PRINTER	24
9. TO CLEAR DATA	24
PRINTER	25
LOADING A ROLL OF PAPER	25
REMOVING A ROLL OF PAPER	25
OPERATING THE PRINTER	25
MAINTENANCE	25
REPLACING THE RIBBON (NO PAPER IN THE PRINTER)	26
REPLACING THE RIBBON (WITH PAPER IN THE PRINTER)	26
MAINTENANCE AND CLEANING	27
CLEANING THE CONDENSER	27
CLEANING THE STORAGE COMPARTMENT	27
WIRING DIAGRAMS	28
COMPUTER CONNECTION	31
PARTS LIST	32
STANDARD WARRANTY	33
ORDERING PRINTER SUPPLIES (RIBBON & PAPER)	34

INTRODUCTION

The Model AP10BCF100-2 Blast Chiller/Shock Freezer is used to rapidly chill cooked foods to temperatures suitable for refrigerated or frozen storage. It has a capacity of up to (10) 12" x 20" x 2.5" pans (pans not included).

Model AP10BCF100-2, in chiller mode, is capable of lowering the core temperature of up to 100 lbs. of food from 160° F to 40° F within 90 minutes. In Shock Freeze mode it is capable of lowering the core temperature of up to 60 lbs. of food from 160° F to 0° F within 4 hours.

Model AP10BCF100-2 can have as options UV sterilization, an integral temperature recording device (printer), stainless steel wire shelves, a second heated probe or a total of three non heated probes. It employs a high velocity flow of cooled air to assure even cooling of the food product, and to quickly bring the food temperature through the danger zone in which bacteria multiply rapidly. This is done in accordance with HACCP, FDA and all state regulations.

CONTROLLER FEATURES

The electronic control system is solid state and is based on the latest microprocessor technology. The display is VFD Industrial Type. It displays (4) lines of 20 characters each and allows operator viewing from any angle. The display is programmed to show clear step-by-step instructions and operating data. It is capable of storing 250 sets of data and 150 recipes. The unit has built-in safety and self-diagnostic systems. The controller notifies the operator if various faults, as listed below, should occur:

- Power supply failure / Restoration of power
- Faulty air temperature probe
- Faulty food temperature probe
- High air temperature (above 140° F)
- Low air temperature (below -35° F)
- High food temperature (above 180° F)
- Low food temperature (below 35° F)
- Excessively high or low pressures.

As an option, the unit can be operated by a PC. The PC interface allows the operator to remotely program the unit, operate it, download the data and print the data.

OPERATING MODES

The operator can choose from the following modes:

AUTOMATIC MODE

This is the preferred mode, in which the food probe is active and takes part in controlling the chilling or freezing processes. The cycle will never proceed to its next step until the food probe has reached its set breaking temperature. The operator needs only to select the recipe number of the food to be processed (up to 150 recipes can be programmed), then insert the probe into the food. It is recommended that the operator remove the food when its temperature starts to flash and the display shows "Ready". The unit will automatically switch into holding mode (cavity air temperature between 35° F and 42° F) when the food has reached the end cycle programmed temperature.

MANUAL MODE

Operating time is set manually, by the operator, for the meal that has been chosen. Air temperature is controlled by the air probe. If the food probe has been inserted into the food it will provide temperature readouts only. The unit will automatically switch into the holding mode at the end of the cycle.

OPERATING CYCLES

The operator can choose from the following 3 operating cycles:

MODE	END FOOD TEMP	USES	NOTES:
SOFT CHILL	38 ° F TO 40° F	FOR LOW DENSITY FOODS	AIR TEMP. IS 28° F TO 35° F
HARD CHILL	38° F TO 40° F	FOR MEDIUM & HIGH DENSITY FOODS	AIR TEMP. STARTS AT 0° F, RISES TO 28° F TO 35° F WHEN FOOD CORE TEMP. REACHES 60° F
SHOCK FREEZE	0° F	FREEZE FOR LONGER STORAGE	AIR TEMP. IS HELD AT -25° F

NOTE: All Chill & Freeze Cycles automatically go into HOLDING MODE when the selected food core temperature is reached and remain there until the operator stops the cycle.

ADDITIONAL CYCLES

MODE	USES	NOTES
DEFROST	TO DEFROST THE EVAPORATOR, NOT THE FOOD	USE AFTER SHOCK FREEZING CYCLE
UV	TO STERILIZE THE CAVITY, NOT THE FOOD	USE WHEN DESIRED
HEAT PROBE	TO HEAT THE FOOD PROBE	ALLOWS EASIER EXTRACTION FROM THE FOOD

PRINTER (OPTIONAL)

An optional strip recorder provides a record of the unit’s operating parameters during the cycle and the following holding period. The information recorded includes date, time, cycle identification, product identification and product core temperature at prescribed intervals.

PC CONNECTION (OPTIONAL)

The unit can be programmed and operated from a remote PC via modem and software (Windows 95, 98, NT, XP). Maximum distance is 4000 ft. Full instructions are supplied on a computer disc, which is furnished when the computer connection is ordered.

INSTALLATION

WARNINGS

READ AND CAREFULLY FOLLOW ALL OF THE INSTRUCTIONS IN THIS MANUAL BEFORE YOU ATTEMPT TO INSTALL THIS EQUIPMENT.

NOTE: Any changes made to the equipment without authorization from the factory will void the warranty.

PREPARATION

- ✓ Check the integrity of the unit once it is unpacked.
- ✓ Check to make sure the floor is level.
- ✓ Check that the available power supply (Voltage, # of phases, Hz, Amps, max. fuse size) corresponds to the ratings on the nameplate and that correctly rated electrical protection is provided (**VOLTAGE MUST BE WITHIN ± 5% FROM THE NAMEPLATE VALUE**).

INSTALLATION

DIMENSIONS

Overall dimensions are 29 1/2" left to right, 28 1/4" front to back, 60 1/2" height. With the door open 90° the front to back distance is 55-1/2".

LOCATION

Ambient air temperature must be **no greater than 90°F** to ensure the rated performance.

Do NOT install the unit near a heat source, in an area exposed to direct sunlight, or in a closed area with high temperatures and insufficient air change.

Level the unit by rotating its adjustable feet, ensuring that the weight of the unit is off the legs when doing so.

Make certain that the unit is correctly leveled - correct functioning may be compromised if it is not.

Mount the rails for the drain pan, using the screws sent with the unit. The mounting inserts are already in place under the unit. Slide the drain pan on the rails.

Plug the power supply cord into a proper outlet in accordance with the chart below.

MODEL	VOLTAGE	Hz	HP	AMPS	NEMA
AP10BCF100-2	208, 1 PH	60	1.2	12	L6-20P

SPACES AROUND THE CABINET

- At least 1" clear space is required on the right side of the cabinet for air flow and service.
- At least 2.5" clear space is required on the left side of the cabinet for door opening and air flow.
- At least 3" clear space is required on the rear of the cabinet for optimum air flow.
- Enough space should be provided in front of the cabinet to fully open the door.

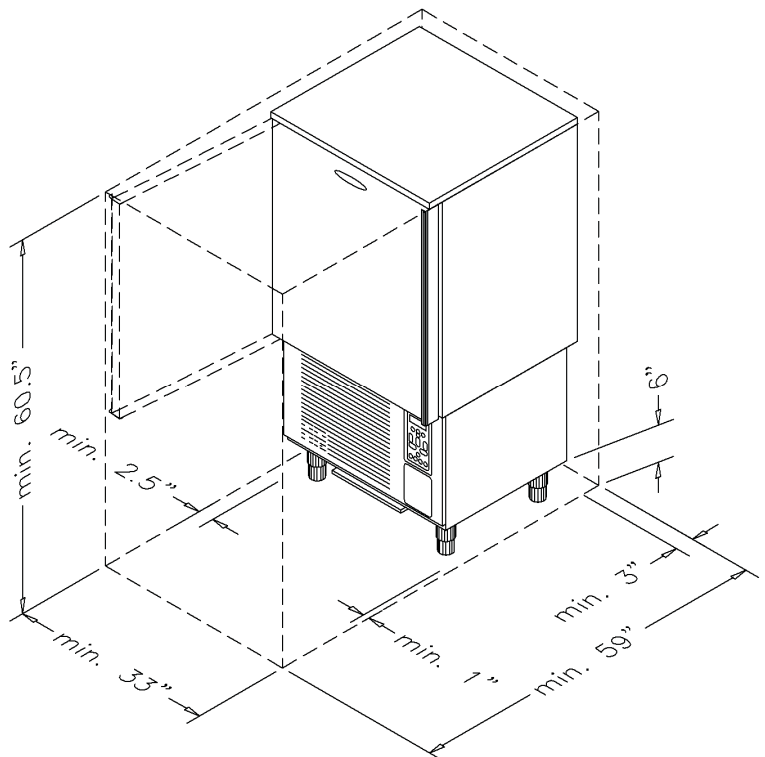

USING THE HURRICHILL™ TECHNOLOGY

BLAST CHILLING

All cooked food rapidly loses its quality and aroma if it is not served promptly. Natural bacteria growth, the main reason why food becomes stale, takes place at an exponential rate between 140°F and 40°F. However lower temperatures have a hibernating effect that increases as the temperature drops, thereby gradually reducing bacterial activity until it stops altogether. Only fast reduction of the temperature at the product's core allows its initial characteristics to be maintained intact. The HurriChill™ blast chiller gets food through this high-risk temperature band rapidly, cooling the core of the product to 40°F within 90 minutes. This conserves food quality, color and aroma while increasing its storage life. After blast chilling, the food can be preserved at 38°F for up to 5 days.

SHOCK FREEZING

For storage over the medium-long term, food has to be shock frozen (to 0°F or below). Freezing means converting the water contained in food into crystals. Thanks to the high speed at which low temperature penetrates the food, the HurriChill™ shock freezer assures the formation of small crystals (micro-crystals) that do not damage the product in any way. Uncooked raw materials, semi-processed food and cooked food can be treated safely. When the food is thawed, no liquids, consistency, weight or aroma will be lost, and all its initial qualities will remain unchanged.

SOFT CHILL CYCLE

(160°F to 40°F)

This cycle is recommended for "delicate", light, thin products or small piece sizes, such as vegetables, creams, sweets, fish products and fried foods. Soft chilling lowers the food temperature quickly, but extremely delicately so as not to damage the outside of the food. This is the ideal cycle to chill any food quickly but delicately, even in haute cuisine.

HARD CHILL CYCLE

(160°F TO 40°F)

Hard chilling is suited for "dense" products and products with a high fat content, in large pieces or those products typically more difficult to chill. Careful chilling control ensures that the end temperature of 40°F is reached at the core of the product, with no danger of freezing and damaging the product, not even on its surface.

SHOCK FREEZE CYCLE















(160°F TO 0°F)

This cycle is recommended when you want to store food for several weeks or months, at temperatures below 0°F. Freezers are suited for storing ready frozen foods, but not for freezing them. During shock freezing, the liquids contained in the food are transformed into micro-crystals that do not harm the tissue structure. When the food is used and thawed, its quality will be excellent. It is especially suited for all semi-processed food and raw products.







CONTROL PANEL FOR MODEL AP10BCF100-2 BLAST CHILLER



KEYBOARD KEYS

<p>ON/OFF & START/STOP</p> <p> ON/OFF</p> <p> START/STOP</p>	<p>CYCLE KEYS</p> <p> SOFT CYCLE</p> <p> HARD CYCLE</p> <p> SHOCK CYCLE</p>
<p>PROGRAMMING KEYS</p> <p> UP</p> <p> DOWN</p> <p> SELECT</p> <p> ENTER</p>	<p> AUTOMATIC CYCLE</p> <p> MANUAL CYCLE</p> <p> UV LIGHT CYCLE</p> <p> DEFROST CYCLE</p> <p> PRINT</p> <p> HEAT PROBE CYCLE</p>





























KEY COMBINATIONS



- **Initial Programming** state – to initially set the device
 - With the display reading **"OFF"**, press and hold  (**"START/STOP"**) for 5 seconds
- **Cycles programming** state – to initially set the cycles
 - With the display reading **"OFF"**, press  (**"ENTER"**) for 1 second
- **Recipe name programming** state – to enter recipe names
 - With the display reading **"OFF"**, press  (**"A"**) for 10 seconds
- **Load default values** state – to load the standard parameters
 - With the display reading **"OFF"**, press  (**"UP"**) for 10 seconds
- **Clear events memory** state – to clear obsolete data
 - With the display reading **"OFF"**, press  +  (**"UP"+"DOWN"**) for 10 seconds
- **Ready To Go** state – in order to start a cycle
 - If the controller is not **"OFF"**, press  **"ON/OFF"** once.

PROGRAMMING

1. INITIAL PROGRAMMING

NOTE: Initial programming is preset at the factory. Use this section only if changes are desired. If no changes are to be made, skip to Page 12 (2. Programming the cycles).

<p>a. With the display reading "OFF", press  ("START/STOP") for a few seconds.</p>	<p>OFF</p>	
<p>b. To change the language, press  or  then press .</p>	<p>INITIAL PROGRAMMING SELECT LANGUAGE ENGLISH</p>	<p>ENGLISH Blinks</p>
<p>c. Enter the default password by pressing, in order, the    and  buttons.</p>	<p>INITIAL PROGRAMMING ENTER PASSWORD: ***</p>	
<p>d. If you do not wish to change the password, press .</p> <p>To change the default password, press  or  for "YES" then press .</p>	<p>INITIAL PROGRAMMING CHANGE PASSWORD? NO</p>	
<p>The password will always be a combination of three of the six available cycles:</p> <div style="display: flex; align-items: center; gap: 10px;">       </div> <p>("SOFT", "HARD", "SHOCK", "DEF", "UV", "HEAT PROBE").</p> <p>Type the new password, then press .</p> <p>Be sure to remember the new password and keep a record of it in a safe place.</p>		
<p>e. To change the year, press  or  then press .</p>	<p>INITIAL PROGRAMMING SET YEAR 2006</p>	<p>2006(year) Blinks</p>
<p>f. To change the month, press  or  then press .</p>	<p>INITIAL PROGRAMMING SET MONTH 07</p>	<p>07(month) Blinks</p>
<p>g. To set the day, press  or  then press .</p>	<p>INITIAL PROGRAMMING SET DAY 03</p>	<p>03(day) Blinks</p>

h. To set the hour, press  or  (be sure to continue to press the buttons until the hour and "AM" or "PM" show correctly) then press .

INITIAL PROGRAMMING
SET TIME 10:25 AM



10(hours) Blinks

i. To set the minutes, press  or  then press .

INITIAL PROGRAMMING
SET TIME 10:25 AM

25(minutes) Blinks



The high air alarm temperature should be left at 140 °F. However, if a change is desired:

j. To change the temperature, press  or  then press .

INITIAL PROGRAMMING
HIGH AIR ALARM 140 °F



140 Blinks

The low air alarm temperature should be left at -35 °F. However, if a change is desired:

k. To change the temperature, press  or  then press .

INITIAL PROGRAMMING
LOW AIR ALARM -35 °F

-35 Blinks



l. To change the number of probes, press  or  then press .

INITIAL PROGRAMMING
FOOD PROBES NUMBER? 1

1 Blinks

NOTE: Standard Configuration has only one food probe. However, a maximum of two heated probes or three non heated probes can be used with this model.



The high food alarm temperature should be left at 180 °F. However, to make a change:

m. To change the temperature, press  or  then press .

INITIAL PROGRAMMING
HIGH FOOD ALARM 180 °F



180 Blinks

The low food alarm temperature should be left at 35 °F. However, to make a change:

n. To change the temperature, press  or  then press .



























INITIAL PROGRAMMING
SOFT & HARD LOW FOOD ALARM 35 °F



35 Blinks

o. To change to **YES** or **NO**, press  or  then press .

INITIAL PROGRAMMING
SHOCK FREEZE? YES



YES Blinks

<p>p. To change the temperature, press  or  then press .</p>	<p>INITIAL PROGRAMMING SHOCK FREEZE LOW FOOD ALARM -5 °F</p>	<p>-5 Blinks</p>
<p>q. To change to YES or NO, press  or  then press .</p>	<p>INITIAL PROGRAMMING UV CYCLE? NO</p>	<p>NO Blinks</p>
<p>r. To change to YES or NO, press  or  then press .</p>	<p>INITIAL PROGRAMMING DEFROST CYCLE? YES</p>	<p>YES Blinks</p>
<p>s. To change to YES or NO, press  or  then press .</p>	<p>INITIAL PROGRAMMING PC CONNECTION? NO</p>	<p>NO Blinks</p>
<p>For YES, the display will show: The P.C. baud rate should be left at 38400. However, to make a change:</p>	<p>INITIAL PROGRAMMING PC BAUDRATE 38400</p>	<p>38400 Blinks</p>
<p>t. To change the baud rate, press  or  then press .</p>		
<p>u. To change the number (between 01 & 32), press  or  then press .</p>	<p>INITIAL PROGRAMMING CHILLER NETWORK ID # 01</p>	<p>01 Blinks</p>
<p>v. To change to YES or NO, press  or  then press .</p>	<p>INITIAL PROGRAMMING PRINTER CONNECTION? NO</p>	<p>NO Blinks</p>
<p>For YES, the display will show: The printer baud rate should be left at 1200. However, to make a change:</p>	<p>INITIAL PROGRAMMING PRINTER BAUDRATE 1200</p>	<p>1200 Blinks</p>
<p>w. To change the baud rate, press  or  then press .</p>		
<p>x. To change the timing, press  or  then press .</p>	<p>INITIAL PROGRAMMING PRINT & SAVE EVENTS EVERY 15 MIN</p>	<p>15 Blinks</p>

y. To change to **YES** or **NO**, press  or  then press .



INITIAL PROGRAMMING
PRINT DURING CYCLE
NO

 Blinks

z. To change to **YES** or **NO**, press  or  then press .

INITIAL PROGRAMMING
RECIPES?
NO

 Blinks

aa. To change to **YES** or **NO**, press  or  then press .

INITIAL PROGRAMMING
NAFEM COMMUNICATION
NO

 Blinks

The display will show:

INITIAL PROGRAMMING
COMPLETE

NOTE: During programming  key can be used to return to the previous screen (except at the steps 1h, 1i and 3d, when it has different functions).

 key is used to confirm the settings and advance to the next screen.

2. PROGRAMMING THE CYCLES

a. With the display reading "**OFF**", press .

OFF

b. Enter your password (see page 9), then press .

PARAM. PROGRAMMING
ENTER PASSWORD

AUTOMATIC SOFT CYCLE PARAMETERS PROGRAMMING

The **LED** for "**A**" will be "**ON**".
The **LED'S** for cycles will be blinking.













PARAM. PROGRAMMING
AUTOMATIC MODE
CHOOSE
PROGRAMMING CYCLE

c. Press . The **LED** for "**SOFT**" will be "**ON**".













d. To change the temperature, press  or  then press .













PARAM. PROGRAMMING
AUTOMATIC SOFT CYCLE
LOW AIR TEMPERATURE
28 °F

 Blinks













<p>e. To change the temperature, press  or  then press .</p>	<p>PARAM. PROGRAMMING AUTOMATIC SOFT CYCLE HIGH AIR TEMPERATURE 35 °F</p>	<p>35 Blinks</p>
<p>f. To change the temperature, press  or  then press .</p>	<p>PARAM. PROGRAMMING AUTOMATIC SOFT CYCLE FOOD TEMPERATURE 40 °F</p>	<p>40 Blinks</p>
<p>g. To change the temperature, press  or  then press .</p>	<p>PARAM. PROGRAMMING AUTOMATIC SOFT CYCLE HOLDING LOW TEMP. 35 °F</p>	<p>35 Blinks</p>
<p>h. To change the temperature, press  or  then press .</p>	<p>PARAM. PROGRAMMING AUTOMATIC SOFT CYCLE HOLDING HIGH TEMP. 42 °F</p>	<p>42 Blinks</p>
<p>The display will show:</p>	<p>PARAM. PROGRAMMING AUTOMATIC SOFT CYCLE PROGRAMMING COMPLETE</p>	

AUTOMATIC HARD CYCLE PARAMETERS PROGRAMMING

<p>After about 2 seconds the display will automatically change to:</p>	<p>PARAM. PROGRAMMING AUTOMATIC MODE CHOOSE PROGRAMMING CYCLE</p>	
<p>i. Press the  button. The LED for "HARD" will be "ON".</p>		
<p>j. To change the temperature, press  or  then press .</p>	<p>PARAM. PROGRAMMING AUTOMATIC HARD CYCLE LOW AIR TEMP PART 1 0 °F</p>	<p>0 Blinks</p>
<p>k. To change the temperature, press  or  then press .</p>	<p>PARAM. PROGRAMMING AUTOMATIC HARD CYCLE HIGH AIR TEMP PART 1 10 °F</p>	<p>10 Blinks</p>
<p>l. To change the temperature, press  or  then press .</p>	<p>PARAM. PROGRAMMING AUTOMATIC HARD CYCLE BREAKING TEMP 60 °F</p>	<p>60 Blinks</p>
<p>m. To change the temperature, press  or  then press .</p>	<p>PARAM. PROGRAMMING AUTOMATIC HARD CYCLE LOW AIR TEMP PART 2 28 °F</p>	<p>28 Blinks</p>

<p>n. To change the temperature, press  or  then press .</p>	<p>PARAM. PROGRAMMING AUTOMATIC HARD CYCLE HIGH AIR TEMP PART 2 35 °F</p>	<p>35 Blinks</p>
<p>o. To change the temperature, press  or  then press .</p>	<p>PARAM. PROGRAMMING AUTOMATIC HARD CYCLE HARD FOOD TEMP. 40 °F</p>	<p>40 Blinks</p>
<p>p. To change the temperature, press  or  then press .</p>	<p>PARAM. PROGRAMMING AUTOMATIC HARD CYCLE HOLDING LOW TEMP. 35 °F</p>	<p>35 Blinks</p>
<p>q. To change the temperature, press  or  then press .</p>	<p>PARAM. PROGRAMMING AUTOMATIC HARD CYCLE HOLDING HIGH TEMP. 42 °F</p>	<p>42 Blinks</p>
<p>The display will show:</p>	<p>PARAM. PROGRAMMING AUTOMATIC HARD CYCLE PROGRAMMING COMPLETE</p>	

AUTOMATIC SHOCK CYCLE PARAMETERS PROGRAMMING

<p>After about 2 seconds the display will automatically change to:</p>	<p>PARAM. PROGRAMMING AUTOMATIC MODE CHOOSE PROGRAMMING CYCLE</p>	
<p>r. Press the  button. The LED for "SHOCK" will be "ON".</p>		
<p>s. To change the temperature, press  or  then press .</p>	<p>PARAM. PROGRAMMING AUTOMATIC SHOCK CYCLE LOW AIR TEMPERATURE -25 °F</p>	<p>-25 Blinks</p>
<p>t. To change the temperature, press  or  then press .</p>	<p>PARAM. PROGRAMMING AUTOMATIC SHOCK CYCLE HIGH AIR TEMPERATURE -15 °F</p>	<p>-15 Blinks</p>
<p>u. To change the temperature, press  or  then press .</p>	<p>PARAM. PROGRAMMING AUTOMATIC SHOCK CYCLE FOOD TEMPERATURE 0 °F</p>	<p>0 Blinks</p>
<p>v. To change the temperature, press  or  then press .</p>	<p>PARAM. PROGRAMMING AUTOMATIC SHOCK CYCLE HOLDING LOW TEMP -4 °F</p>	<p>-4 Blinks</p>

w. To change the temperature, press  or  then press .

PARAM. PROGRAMMING
 AUTOMATIC SHOCK CYCLE
 HOLDING HIGH TEMP
 3 °F

 Blinks

The display will show:



PARAM. PROGRAMMING
 AUTO SHOCK CYCLE
 PROGRAMMING COMPLETE

UV LIGHT CYCLE PARAMETERS PROGRAMMING

After about 2 seconds the display will automatically change to:

x. Press the  button. The LED for "UV LIGHT" will be "ON".

PARAM. PROGRAMMING
 AUTOMATIC MODE
 CHOOSE
 PROGRAMMING CYCLE

y. To change the time, press  or  then press .

PARAM. PROGRAMMING
 UV CYCLE
 CYCLE TIME
 H 00:30 MIN

 Blinks

The display will show:



PARAM. PROGRAMMING
 UV CYCLE
 PROGRAMMING COMPLETE

DEFROST CYCLE PARAMETERS PROGRAMMING

After about 2 seconds the display will automatically change to:

z. Press the  button. The LED for "DEFROST" will be "ON".

PARAM. PROGRAMMING
 AUTOMATIC MODE
 CHOOSE
 PROGRAMMING CYCLE

aa. To change the time, press  or  then press .

PARAM. PROGRAMMING
 DEFROST CYCLE
 TOTAL TIME
 05 MIN

 Blinks

The display will show:

PARAM. PROGRAMMING
 DEFROST CYCLE
 PROGRAMMING COMPLETE



NOTE: The defrost is done by running the evaporator fan for 5 minutes with the door open.

HEATED PROBE CYCLE PARAMETERS PROGRAMMING

After about 2 seconds the display will automatically change to:



PARAM. PROGRAMMING
AUTOMATIC MODE
CHOOSE
PROGRAMMING CYCLE

bb. Press the  button. The LED for "HEATED PROBE" will be "ON".

cc. To change the temperature, press  or 
then press .

PARAM. PROGRAMMING
HEATED PROBE CYCLE
HEATING TEMPERATURE
30 °F

 Blinks

dd. To change the time, press  or 
press .

PARAM. PROGRAMMING
HEATED PROBE CYCLE
HEATING TIME
05 SEC

 Blinks

The display will show:

PARAM. PROGRAMMING
HEATED PROBE CYCLE
PROGRAMMING COMPLETE

After about 2 seconds the display will automatically change to:



PARAM. PROGRAMMING
AUTOMATIC MODE
CHOOSE
PROGRAMMING CYCLE

ee. Press  to program the manual mode. The "M" LED will be steady "ON" and the 6 "CYCLE LED's" will all blink.

MANUAL SOFT CYCLE PARAMETERS PROGRAMMING



ff. Press . The LED for "SOFT" will be "ON".

PARAM. PROGRAMMING
MANUAL MODE
CHOOSE
PROGRAMMING CYCLE

gg. To change the temperature, press  or 
then press .

PARAM. PROGRAMMING
MANUAL SOFT CYCLE
LOW AIR TEMPERATURE
28 °F

 Blinks

hh. To change the temperature, press  or 
then press .







PARAM. PROGRAMMING
MANUAL SOFT CYCLE
HIGH AIR TEMPERATURE
35 °F

 Blinks



















ii. To change the time, press  or 
press .







PARAM. PROGRAMMING
MANUAL SOFT CYCLE
TOTAL TIME
H 01:30 MIN

 Blinks

















<p>jj. To change the temperature, press  or  then press .</p>	<p>PARAM. PROGRAMMING MANUAL SOFT CYCLE HOLDING LOW TEMP 35 °F</p>	<p>35 Blinks</p>
<p>kk. To change the temperature, press  or  then press .</p>	<p>PARAM. PROGRAMMING MANUAL SOFT CYCLE HOLDING HIGH TEMP 42 °F</p>	<p>42 Blinks</p>
<p>The display will show:</p>		<p>PARAM. PROGRAMMING MANUAL SOFT CYCLE PROGRAMMING COMPLETE</p>

MANUAL HARD CYCLE PARAMETERS PROGRAMMING

<p>After about 2 seconds the display will automatically change to:</p>		<p>PARAM. PROGRAMMING MANUAL MODE CHOOSE PROGRAMMING CYCLE</p>
<p>ll. Press the  button. The LED for "HARD" will be "ON".</p>		
<p>mm. To change the temperature, press  or  then press .</p>	<p>PARAM. PROGRAMMING MANUAL HARD CYCLE LOW AIR TEMP PART 1 0 °F</p>	<p>0 Blinks</p>
<p>nn. To change the temperature, press  or  then press .</p>	<p>PARAM. PROGRAMMING MANUAL HARD CYCLE HIGH AIR TEMP PART 1 10 °F</p>	<p>10 Blinks</p>
<p>oo. To change the time, press  or  then press .</p>	<p>PARAM. PROGRAMMING MANUAL HARD CYCLE TIME 1 H 01:00 MIN</p>	<p>01:00 Blinks</p>
<p>pp. To change the temperature, press  or  then press .</p>	<p>PARAM. PROGRAMMING MANUAL HARD CYCLE LOW AIR TEMP PART 2 28 °F</p>	<p>28 Blinks</p>
<p>qq. To change the temperature, press  or  then press .</p>	<p>PARAM. PROGRAMMING MANUAL HARD CYCLE HIGH AIR TEMP PART 2 35 °F</p>	<p>35 Blinks</p>
<p>rr. To change the time, press  or  then press .</p>	<p>PARAM. PROGRAMMING MANUAL HARD CYCLE TIME 2 H 01:00 MIN</p>	<p>01:00 Blinks</p>

<p>ss. To change the temperature, press  or  then press .</p>	<p>PARAM. PROGRAMMING MANUAL HARD CYCLE HOLDING LOW TEMP. 35 °F</p>	<p>35 Blinks</p>
<p>tt. To change the temperature, press  or  then press .</p>	<p>PARAM. PROGRAMMING MANUAL HARD CYCLE HOLDING HIGH TEMP. 42 °F</p>	<p>42 Blinks</p>
<p>The display will show:</p>	<p>PARAM. PROGRAMMING MANUAL HARD CYCLE PROGRAMMING COMPLETE</p>	

MANUAL SHOCK CYCLE PARAMETERS PROGRAMMING











<p>After about 2 seconds the display will automatically change to: uu. Press the  button. The LED for "SHOCK" will be "ON".</p>	<p>PARAM. PROGRAMMING MANUAL MODE CHOOSE PROGRAMMING CYCLE</p>	
<p>vv. To change the temperature, press  or  then press .</p>	<p>PARAM. PROGRAMMING MANUAL SHOCK CYCLE LOW AIR TEMPERATURE -25 °F</p>	<p>-25 Blinks</p>
<p>ww. To change the temperature, press  or  then press .</p>	<p>PARAM. PROGRAMMING MANUAL SHOCK CYCLE HIGH AIR TEMPERATURE -15 °F</p>	<p>-15 Blinks</p>
<p>xx. To change the time, press  or  then press .</p>	<p>PARAM. PROGRAMMING MANUAL SHOCK CYCLE TOTAL TIME H 04:00 MIN</p>	<p>04:00 Blinks</p>
<p>yy. To change the temperature, press  or  then press .</p>	<p>PARAM. PROGRAMMING MANUAL SHOCK CYCLE HOLDING LOW TEMP. -4 °F</p>	<p>-4 Blinks</p>
<p>zz. To change the temperature, press  or  then press .</p>	<p>PARAM. PROGRAMMING MANUAL SHOCK CYCLE HOLDING HIGH TEMP. 3 °F</p>	<p>3 Blinks</p>
<p>The display will show:</p>	<p>PARAM. PROGRAMMING MANUAL SHOCK CYCLE PROGRAMMING COMPLETE</p>	





After about 2 seconds the display will automatically change to:

PARAM. PROGRAMMING
MANUAL MODE
CHOOSE
PROGRAMMING CYCLE

NOTE: PROGRAMMING FOR "DEFROST", "UV" & "HEAT PROBE" WILL BE THE SAME IN MANUAL MODE AS IT IS IN AUTOMATIC MODE (see pages 15-16).

3. RECIPE NAME PROGRAMMING











<p>a. With the display reading "OFF", press the  button and hold it for 10 seconds.</p>	<p>OFF</p>	
<p>b. Enter your password (see page 9), then press .</p>	<p>RECIPES PROGRAMMING ENTER PASSWORD ***</p>	
<p>c. Press  or  to change to the desired recipe number (from 1 to 150), then press  which will move you to the "NAME" line.</p>	<p>ENTER RECIPE NUMBER 1 ENTER RECIPE NAME</p>	<p> Blinks</p>
<p>d. Using  or  type the letters or numbers required, then press . To confirm the recipe and go to the next one press .</p>	<p>ENTER RECIPE NUMBER 1 ENTER RECIPE NAME CHICKEN_</p>	<p> Blinks</p>

If a mistake is made in writing a recipe, use  to go to the desired location and correct it using  or . There is a blank space after number 9. It can be used to add a space or delete a letter. Press  when the recipe is corrected.

To finish the recipe name programming press  ("ON/OFF").

OPERATION

1. AUTOMATIC MODE - SOFT CHILL

<p>a. With the display reading "OFF", press the  ("ON/OFF") button.</p>	<p>OFF</p>	
<p>b. To select a cycle, press the appropriate button . The LED for "SOFT" will be "ON".</p>	<p>OPERATING MODE CHOOSE OPERATING CYCLE</p>	
<p>c. The LED's for "AUTOMATIC" and "MANUAL" are now blinking. To select an "AUTOMATIC" cycle, press the button . The LED for "AUTOMATIC" will now be steady "ON".</p>	<p>SOFT CYCLE CHOOSE MODE AUTO / MAN</p>	
<p>d. To choose your recipe, press  or  then press .</p>	<p>RED FOOD PROBE ENTER RECIPE NUMBER 1 CHICKEN</p>	<p> Blinks</p>
<p>This screen is shown only if the RECIPE parameter is set to "ON" in the INITIAL PROGRAMMING. The red food probe only will be active in the standard configuration. To enter additional recipe names, refer to Page 19 "RECIPE NAME PROGRAMMING".</p>		
<p>The display will show: alternating with e. Press the  ("START/STOP") button to start the cycle.</p>	<p>READY TO START PRESS START</p>	<p> Blinks</p>
<p>The display will show: alternating with</p>	<p>03.07.2006 10:28 AM AIR 75°F R / CHICKEN 140°F</p>	<p> Will count up</p>
<p></p>	<p>03.07.2006 00:00 AIR 75°F R / CHICKEN 140°F</p>	<p> Will count up</p>
<p>The AUTOMATIC mode uses both the food probe and air probe temperatures to control the cycle. When the food temperature has reached the final setting of 40° F, the unit will automatically go into holding mode and a beep will sound for 5 seconds. The elapsed time and food temperature readouts will blink.</p>		

The display will show:

alternating with

03.07.2006	11:56 AM
AIR	34°F
R / CHICKEN	40°F

40°F
is alternating
with
Ready

03.07.2006	01:28
AIR	34°F
R / CHICKEN	40°F

01:28 Blinks
40°F
is alternating
with
Ready



The operator can now end this cycle by pressing the  ("START/ STOP") button.

The display will now show:

OPERATING MODE
CHOOSE OPERATING CYCLE

2. MANUAL MODE - SOFT CHILL

a. IF INSTEAD OF AUTOMATIC you wish to select a **MANUAL** cycle, perform steps 1.a, 1.b,

1.c and 1.d (above), except in step 1.c press button  instead of button . The LED for "MANUAL" will then be steady "ON". The four readouts in those steps will be the same as before.

NOTE: Cycle time can be changed only in Cycle Programming mode. To change the programmed cycle time for any cycle see the instructions on Pages 12 to 19.

b. Press the  ("START/STOP") button to start the cycle.

The display will show:

alternating with

03.07.2006	10:41 AM
AIR	75°F
R / CHICKEN	140°F

01:29
Will count
down

03.07.2006	01:29
AIR	75°F
R / CHICKEN	140°F

The **MANUAL** mode uses time and the air probe temperature to control the cycle. The default total time for a soft cycle is 90 minutes. After the 90 minutes the unit will automatically go into holding mode.

The display will show:

alternating with

03.07.2006	12:11 AM
AIR	34°F
R / CHICKEN	40°F

00:00 Blinks

03.07.2006	00:00
AIR	34°F
R / CHICKEN	40°F



The operator can now end this cycle by pressing  ("START/ STOP").

The display will now show:

<p>OPERATING MODE</p> <p>CHOOSE OPERATING CYCLE</p>



3. HARD CHILL CYCLE

To perform a hard chill cycle, follow steps 1 or 2 (above), **EXCEPT** in step 1.b (above) press

 instead of .

4. SHOCK FREEZE CYCLE

To perform a shock freeze cycle, follow steps 1 or 2 (above), **EXCEPT** in step 1.b (above) press

 instead of .

5. UV (STERILIZATION) CYCLE

a. To perform a UV cycle **remove all food**, then press

the  ("UV LIGHT") button.

<p>OPERATING MODE</p> <p>CHOOSE OPERATING CYCLE</p>

b. Press the  ("START/STOP") button to start the UV cycle.

<p>03.07.2006 11:43 AM</p> <p>UV CYCLE</p> <p>READY TO START</p>

**READY TO
START**
Blinks

The display will now show:

<p>03.07.2006 11:43 AM</p> <p>UV CYCLE</p> <p>UV TIME 29:59</p>

29:59
Will count
down to
00:00

After 30 minutes the display will show:
The controller will beep for a few seconds.

<p>03.07.2006 12:13 PM</p> <p>UV CYCLE</p> <p>COMPLETE</p>

6. DEFROST CYCLE

The defrost cycle runs the evaporator fan for 5 minutes with the door open.

a. To perform a defrost cycle, press  ("DEFROST") button.



<p>OPERATING MODE</p> <p>CHOOSE OPERATING CYCLE</p>

b. Open the door.

<p>03.07.2006 12:15 PM</p> <p>DEFROST CYCLE</p> <p>OPEN DOOR!</p>
--

<p>c. Press the  ("START/STOP") button to start the defrost cycle.</p>	<p>03.07.2006 12:15 PM DEFROST CYCLE READY TO START</p>	<p>READY TO START Blinks</p>
<p>The display will now show:</p>	<p>03.07.2006 12:15 PM DEFROST CYCLE DEFROST TIME 04:59</p>	<p>04:59 Will count down to 00:00</p>
<p>After 5 minutes the display will show: The controller will beep for a few seconds.</p>	<p>03.07.2006 12:20 PM DEFROST CYCLE COMPLETE</p>	

7. HEATED FOOD PROBE

<p>a. To select the heated food probe, press  ("HEATED PROBE").</p>	<p>OPERATING MODE CHOOSE OPERATING CYCLE</p>	
<p>If the food probe temperature is >30 °F, the display will show:</p>	<p>HEATED FOOD PROBE NOT NEEDED</p>	
<p>After a few seconds it will go back to reading:</p>	<p>OPERATING MODE CHOOSE OPERATING CYCLE</p>	
<p>If the food probe temperature is <30 °F, the display will show: b. Open the door.</p>	<p>HEAT FOOD PROBE OPEN DOOR!</p>	
<p>c. Press the  ("START/STOP") button to start the cycle.</p>	<p>HEAT FOOD PROBE READY TO START</p>	<p>READY TO START Blinks</p>
<p>The display will now show:</p>	<p>HEATING FOOD PROBES</p>	
<p>After 5 seconds the display will show:</p>	<p>HEATING COMPLETE EXTRACT THE PROBES</p>	



NOTE: To stop any cycle before it has finished, press  ("**START/STOP**").

The controller will beep for a few seconds. If you still





want to stop the cycle, press  ("**START/STOP**") again. If you do **NOT** want to stop, do nothing and the cycle will continue.

UNIT IN PROCESS
DO YOU WANT TO STOP?

8. PREPARING AND USING THE OPTIONAL PRINTER

<p>a. With the display reading "OFF", press the  button.</p>	<div style="border: 1px solid black; padding: 5px; text-align: center;">OFF</div>
<p>b. To start printing, press the  ("START/STOP") button.</p>	<div style="border: 1px solid black; padding: 5px; text-align: center;"> PRINT EVENTS MEMORY READINGS LEFT 249 </div>
<p>After a few seconds the display will show: and the printer will be printing.</p>	<div style="border: 1px solid black; padding: 5px; text-align: center;"> PRINT EVENTS MEMORY PRINTING ... </div>

9. TO CLEAR DATA

<p>a. To clear existing data that is no longer needed from the controller, from the "OFF" display, press  and  together for about 10 seconds.</p>	<div style="border: 1px solid black; padding: 5px; text-align: center;">OFF</div>
<p>b. Press .</p>	<div style="border: 1px solid black; padding: 5px; text-align: center;"> CLEAR EVENTS MEMORY? NO </div> <div style="text-align: right; margin-top: 5px;">NO Blinks</div>
<p>c. Press .</p>	<div style="border: 1px solid black; padding: 5px; text-align: center;"> CLEAR EVENTS MEMORY? YES </div> <div style="text-align: right; margin-top: 5px;">YES Blinks</div>
<p>d. Enter your password, then press .</p>	<div style="border: 1px solid black; padding: 5px; text-align: center;"> CLEAR EVENTS MEMORY? ENTER PASSWORD *** </div>
<p>e. Wait about 40 seconds,</p>	<div style="border: 1px solid black; padding: 5px; text-align: center;"> CLEAR EVENTS MEMORY? PLEASE WAIT ... </div>
<p>after which the display will show, for only 2 seconds:</p>	<div style="border: 1px solid black; padding: 5px; text-align: center;"> CLEAR EVENTS MEMORY? COMPLETE </div>

The display will go back to **"OFF"** and all 440 reading spaces will be available.

PRINTER

NOTE: The optional printer is delivered fully installed

LOADING A ROLL OF PAPER

1. Remove the paper cover by pressing on the groove patterns to pop the front edge up. Lift off the cover.
2. Press the rocker switch to the left. The light will go off.
3. Unroll several inches of paper.
4. Cut a straight edge on the paper roll if it is jagged. This will facilitate the entry of the paper into the printer.
5. Slide the paper (with the roll above the paper) through the slot connecting the paper compartment and the printer compartment. It can be slid in about 1/4" before it stops.
6. While holding the paper in place, press the rocker switch to the Paper Feed position and hold it there. The printer will activate and a rubber roller will pull the paper into the printer compartment. Release the switch when an inch of paper has emerged from the top of the printer.
7. Slide the paper through the slot in the printer cover.
8. Push the back of the printer cover down and into place.
9. Press the front of the printer cover down to lock in place.
10. Put the paper spindle into the paper roll and place the roll with the spindle onto the snaps near the back of the printer. Turn the paper roll to take up any slack. Make sure the roll of paper turns freely. If it does not turn freely, the paper will jam and can possibly damage the printer mechanism.

REMOVING A ROLL OF PAPER

1. Using the Paper Feed Switch, advance the paper about one inch beyond the paper cutter.
2. Lift the paper roll away from the printer housing and cut the paper feeding to the printer with scissors. Try to make the cut as square as possible to help the next time you reload the paper.
3. Pull the remaining paper through the printer mechanism. Be sure to pull the paper from the top (paper cutter side).

WARNING: Pulling the paper out from the back of the printer will damage the print mechanism.

OPERATING THE PRINTER

The Paper Feed switch on the printer is a rocker type switch. Push the left side of the rocker switch to toggle the printer ON or OFF. A red light will go on when the printer switch is ON. Push the right side of the switch to advance the paper.

MAINTENANCE

When printing becomes difficult to see, replace the ribbon in your printer with an Epson HX-20 cartridge ribbon.

If your printer is used infrequently, the print impression may become weak because the ribbon dried out. In that case, advance the ribbon to a new section by holding down the Paper Feed switch for several seconds.

REPLACING THE RIBBON (NO PAPER IN THE PRINTER)

1. Turn the printer OFF.
2. Four small grooves are embossed on each side of the printer cover. Push down on one or both of these areas until the printer cover tilts up, then lift the cover completely off.
3. Push down on the right side of the ribbon cartridge where it is marked "PUSH". Remove the cartridge.
4. Install the new cartridge. Be sure the cartridge is inserted firmly to prevent weak or irregular printing. The cartridge must be properly seated and aligned for best printing
5. Turn the cartridge "knob" (marked by an arrow) clockwise to take up slack.
6. Replace the cover.
7. Replace the paper.

REPLACING THE RIBBON (WITH PAPER IN THE PRINTER)

1. It is possible to insert the ribbon cartridge if there is already paper in the printer.
2. Hold the cartridge at each end with thumb and forefinger and slide it over the paper and into the printer compartment.

Be sure the paper goes between the ribbon cartridge and the ink ribbon. If you get ribbon ink on the printer case, wipe it off immediately as once it dries it is difficult to remove.

MAINTENANCE AND CLEANING

CLEANING THE CONDENSER

For correct and efficient operation of the blast chiller, it is necessary that the condenser be kept clean so that air can circulate around it freely and come into contact with the whole of its surface.



Fig. 1

This operation (to be performed every 30 days, max.) can be accomplished using a brush (non-metallic) to remove all the dust and dirt from the condenser fins. Remove the finned grid to gain access to the condenser.

CLEANING THE STORAGE COMPARTMENT

Clean the inside of the storage compartment daily to avoid altering the taste and aroma of the food.

Clean the inside, the grid supports and the grids with a non-corrosive detergent and then rinse thoroughly.

The storage compartment and its internal components have been designed to aid all cleaning operations.

Clean the outside surfaces regularly with a detergent for stainless steel and dry using a soft cloth.

Always defrost the unit (see manual).

DO NOT USE ABRASIVES, SOLVENTS OR GLASS WOOL (Fig. 3).

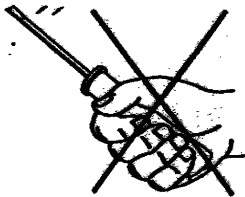

Fig.2

Avoid using sharp implements and abrasives, especially when cleaning the evaporator (Fig. 2).

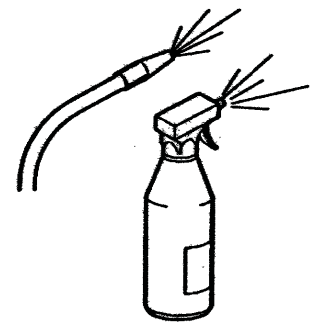
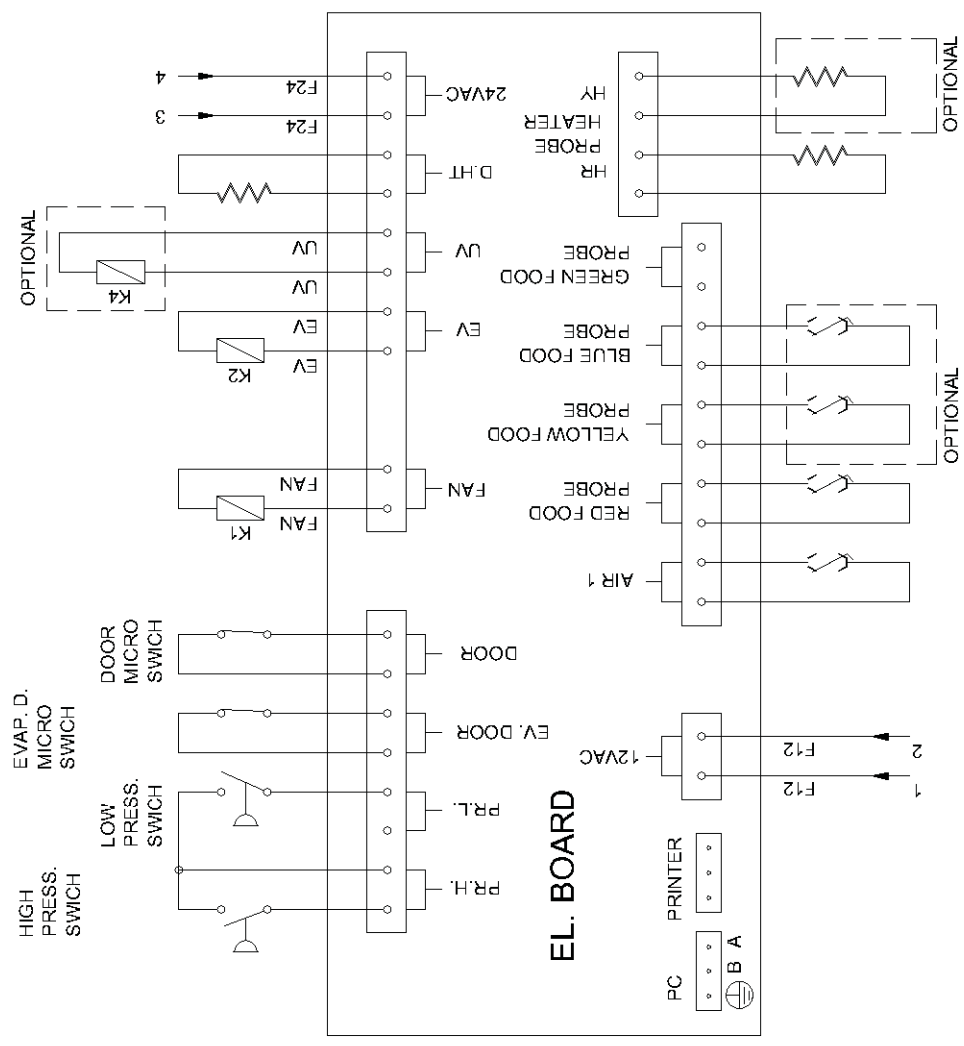

Fig. 3

NOTE: If additional refrigerant should be needed, be certain to use the correct type and amount as shown on the nameplate.

WIRING DIAGRAMS



REV.	DATE	DESCRIPTION	REV. BY	APP. BY	FI
B	07/03/07	TWO NON HEATED PROBES ADDED	RT		



TITLE: WIRING DIAGRAM #1

MODEL: AP7BCF70-2; AP7BCF70-2-C; AP10BCF100-2

DATE: 07/03/07 DRAWN BY: RT P.O.#: REV B

SCALE: NTS DWG#: 98009-00 JOB#: SHEET 1 of 1

This drawing and information contained herein are the exclusive property of American Panel Corporation. It shall be returned to American Panel Corporation upon demand and shall not be reproduced in whole or part, disclosed to anyone else, or used without the written consent of American Panel Corporation.

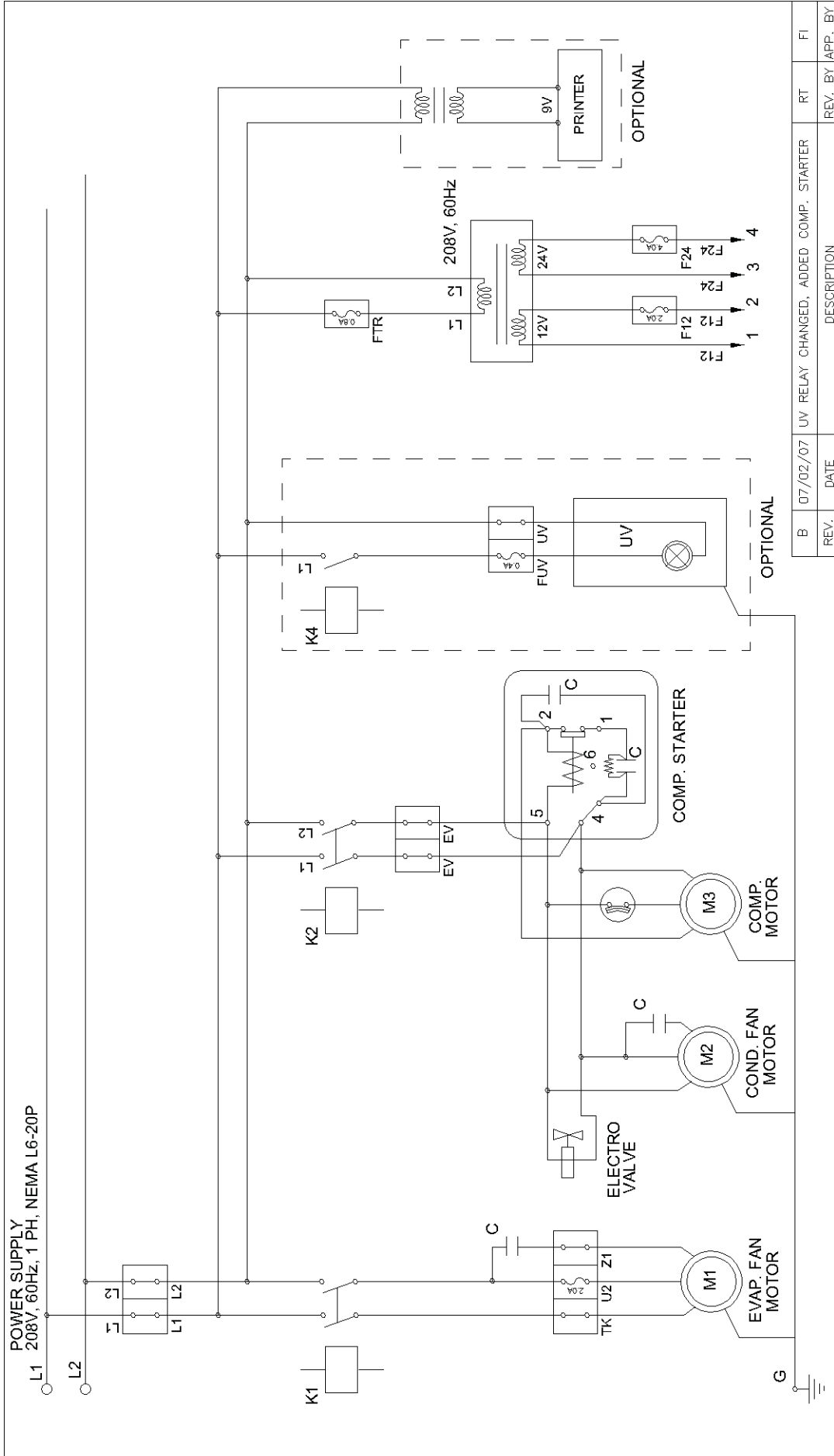

REV.	DATE	DESCRIPTION	REV. BY	APP. BY	FI
B	07/02/07	UV RELAY CHANGED, ADDED COMP. STARTER	RT		

American Panel		AMERICAN PANEL CORPORATION 5800 S.E. 78th St. Ocala, Florida 34472 Ph. (352) 245-7055 Fax (352) 245-0726	
TITLE: WIRING DIAGRAM #2			
MODEL: AP7BCF70-2; AP7BCF70-2-C; AP10BCF100-2			
DATE: 05/08/06	DRAWN BY: RT	P.O.#:	REV
SCALE: NTS	DWG#:	JOB#:	SHEET
	98009-01		1 of 1

This drawing and information contained herein are the exclusive property of American Panel Corporation. It shall be returned to American Panel Corporation upon demand and shall not be reproduced in whole or part, disclosed to anyone else, or used without the written consent of American Panel Corporation.

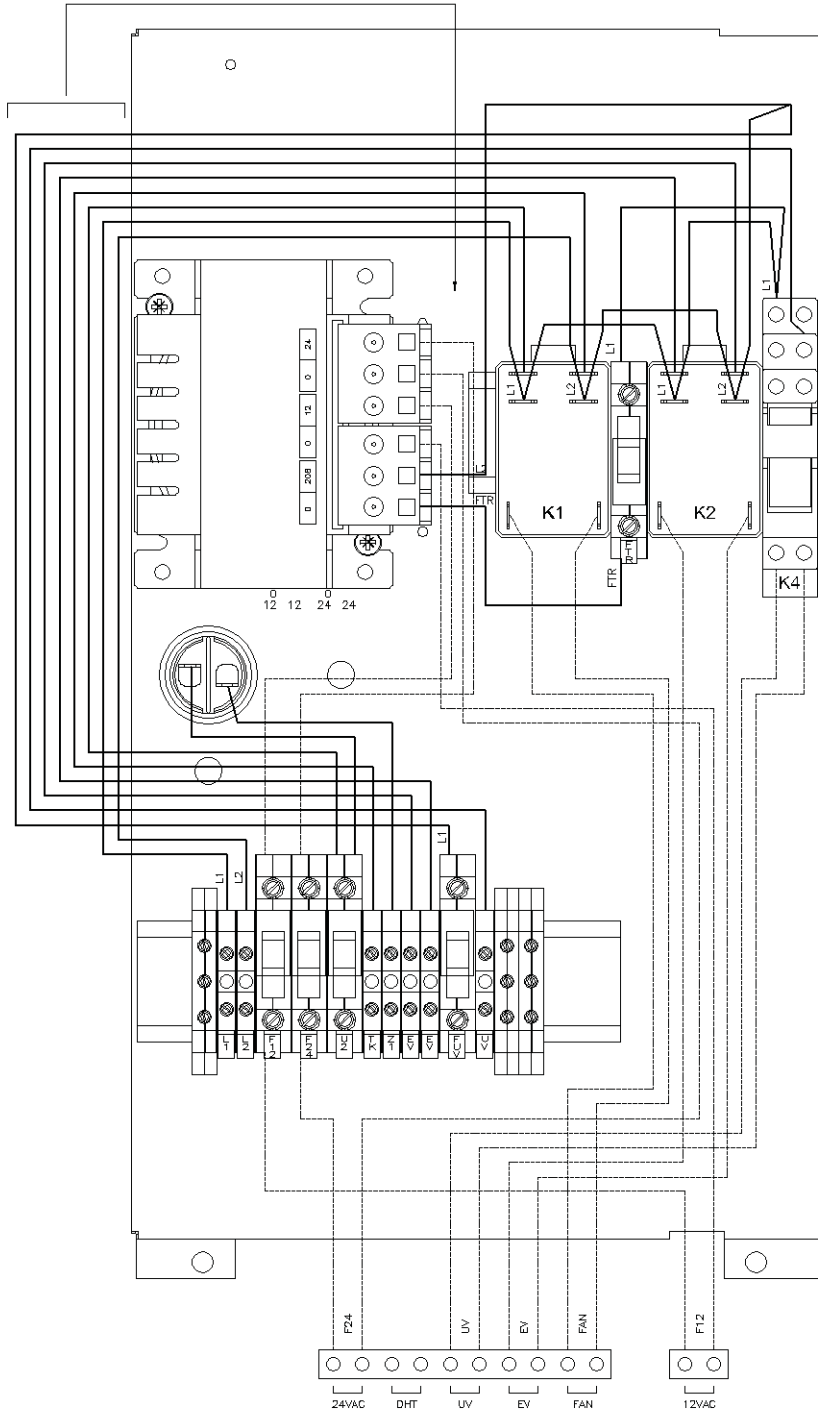

————— 14 AWG BLACK WIRE
 - - - - - 16 AWG RED WIRE

B	07/09/07	NEW RELAYS AND TRANSFORMER	GC	FI
REV.	DATE	DESCRIPTION	REV. BY	APP. BY

This drawing and information contained herein are the exclusive property of American Panel Corporation. It shall be returned to American Panel Corporation upon demand and shall not be reproduced in whole or part, disclosed to anyone else, or used without the written consent of American Panel Corporation.

American Panel AMERICAN PANEL CORPORATION
 5800 S.E. 78th St. Ocala, Florida 34472
 Ph. (352) 245-7055 Fax (352) 245-0726

TITLE: WIRING DIAGRAM #3
 MODEL: AP7BCF70-2
 DATE: 05/05/06 DRAWN BY: GC P.O.#: REV A
 SCALE: NTS DWG#: 98009-02 JOB#: SHEET 1 of 1

COMPUTER CONNECTION

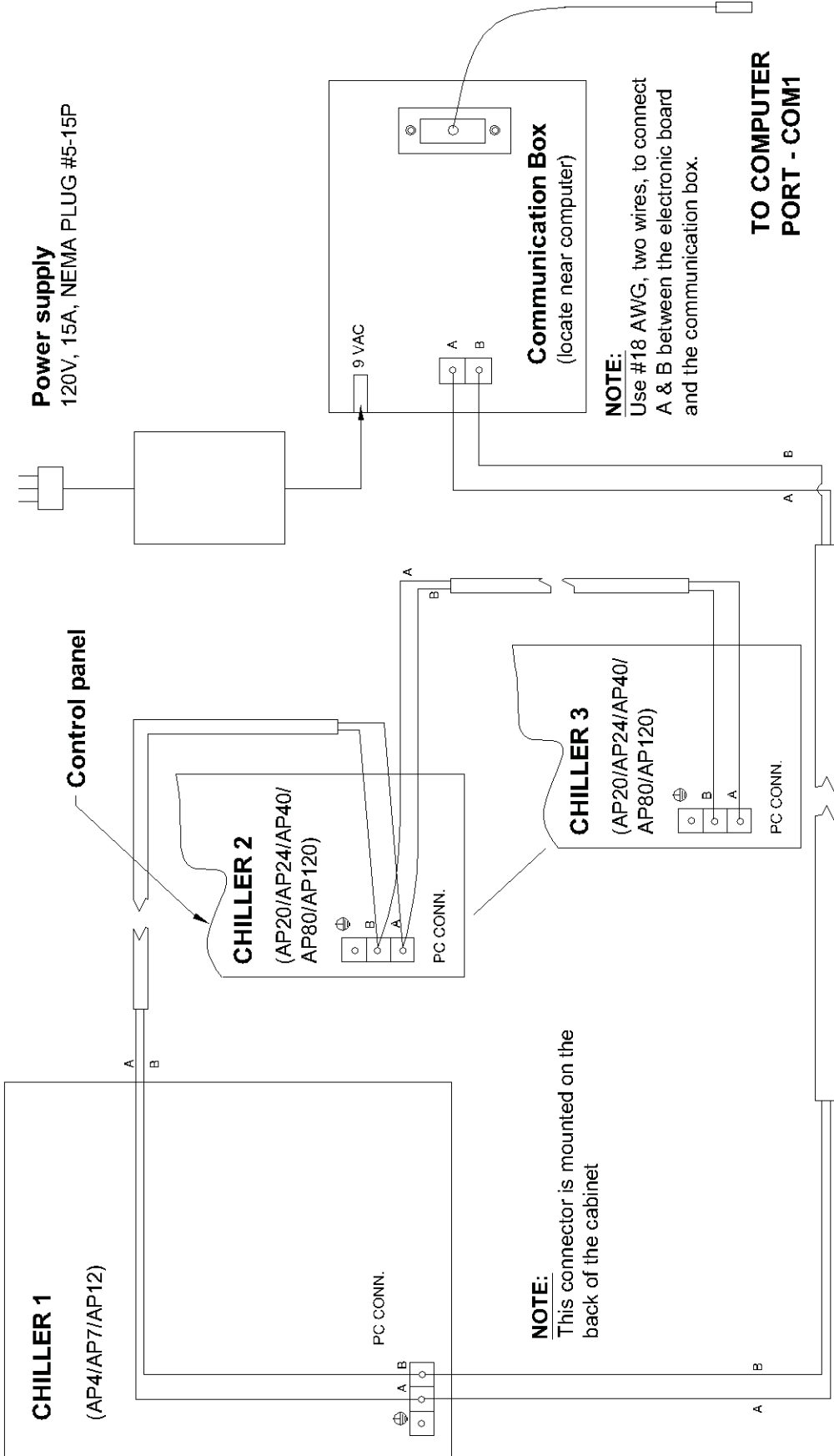

NOTE:
Use #18 AWG, two wires, to connect A & B between the electronic board and the communication box.

NOTE:
This connector is mounted on the back of the cabinet

REV.	DATE	DESCRIPTION	REV. BY	APP. BY

American Panel
 AMERICAN PANEL CORPORATION
 5800 S.E. 78th St. Ocala, Florida 34472
 Ph. (352) 245-7065 Fax (352) 245-0726

TITLE: COMPUTER CONNECTION

MODEL: AP4/AP7/AP12/AP20/AP24/AP40/AP80/AP120

DATE: 06/02/06 DRAWN BY: GC P.O.#: REV: A

SCALE: NTS DWG#: 98018-00 JOB#: SHEET 1 of 1

This drawing and information contained herein are the exclusive property of American Panel Corporation. It shall be returned to American Panel Corporation upon demand and shall not be reproduced in whole or part, disclosed to anyone else, or used without the written consent of American Panel Corporation.

PARTS LIST

PART #	DESCRIPTION
990059	PRINTER
990060	RELAY 10 A FINDER (UV)
990074	TRANSFORMER 208V/24V/12V
990075	TRANSFORMER FOR PRINTER
990102	ELECTRONIC BOARD "BLUE SYS" (C)
990104	PC CONNECTION BOX
990105	CONNECTION CABLE, SERIAL
990108	AIR PROBE PT100
990119	COMPRESSOR ASPERA (R404A REFRIGERANT)
990136	EVAPORATOR FAN
990137	FOOD PROBE – NON HEATED
990145	FOOD PROBE – HEATED
990147	MAGNETIC DOOR SWITCH
990155	SOLENOID DANFOSS
990156	SOLENOID SOCKET
990159	UV LAMP, 6W
990161	PRINTER POWER CABLE
990173	COMPRESSOR STARTER KIT
990175	COND. FAN MOTOR
990178	AC ADAPTOR PC CONNECTION
990191	RELAY 30 A FINDER
991015	CONDENSER
991024	EVAPORATOR
991025	EXPANSION VALVE, TES2
991027	FILTER DRIER
991031	HIGH/LOW PRESSURE SWITCH
991034	LIQUID RECEIVER
991035	SIGHT GLASS
991037	ORIFICE 01
991039	SOLENOID VALVE EVR3
992087	WIRE SHELF AP3/AP5/AP10
993022	DOOR GASKET 30-3/4"X26-1/2"
993028	DRIP PAN

STANDARD WARRANTY

AMERICAN PANEL CORP.

5800 S.E. 78th Street, Ocala, Florida 34472-3412

American Panel Corporation products are warranted to the original user installed within the United States and Puerto Rico to be free from defects in materials and workmanship under normal use and service for the applicable period shown in the chart below.

NOTE: This Warranty does not apply to altered or misused parts.

BLAST CHILLERS / SHOCK FREEZERS (ONLY)

WARRANTY COVERS	PARTS	LABOR
Complete unit	1 year from date of shipment	1 year from date of shipment
COMPRESSOR ONLY	Additional 4 years	NONE
Food probes, UV and incandescent lamps	NONE	NONE

American Panel Corporation agrees to repair or replace at its option, FOB Factory, any part which proves to be defective due to defects in material or workmanship during the warranty period, providing the equipment has been properly installed, maintained and operated in accordance with the HurriChill™ User’s Manual. Refer to the above chart for details and exceptions for various equipment items. Labor covered by this warranty must be authorized by American Panel Corporation and performed by a factory-authorized service agency.

This warranty does not apply to remote or pre-assembled remote refrigeration systems requiring electrical inter-wiring or refrigerant piping provided by others. In no event shall American Panel Corporation be liable for the loss of use, revenue or profit or for any other indirect, incidental, special or consequential damages including, but not limited to, losses involving food spoilage or product loss. American Panel Corporation reserves the right to withdraw this warranty if it is determined that the equipment is not being operated properly. There are no other warranties expressed or implied.

During the warranty period, all requests for service **MUST** be made before any work is begun. Such requests must be directed to American Panel Corporation Service Department, which will issue written authorization when applicable. Without this authorization, the Warranty may be voided. The Service Department can be contacted by mail at American Panel Corp., 5800 S.E. 78th Street, Ocala, Florida 34472-3412; or by telephone at 1-800-327-3015; or by fax at (352) 245-0726.

Proper installation is the responsibility of the dealer, the owner-user, or the installing contractor. It is not covered by this Warranty.

ORDERING PRINTER SUPPLIES (RIBBON & PAPER)

Replacement paper and ribbons for the optional printer for your blast chiller can be ordered from a local distributor of Weigh-Tronix supplies.

To locate a distributor near you:

If you have access to the internet:

- Go to www.wtxweb.com
- Enter your zip code or city / state

If you do not have access to the internet:

- Call American Panel at 1-800-327-3015

Listing of Weigh-Tronix items and part numbers:

Weigh-Tronix Item Description	Weigh-Tronix Part Number
Paper (Roll)	22335-0018
Ribbon, Black	22332-0029