

Installation & Operators Manual

Modular self-contained blast chillers & shock freezers

MODELS COVERED:
AP20BCF200-3-XL



*Please read this manual
before installing or
operation of this equipment.*



Versatile, Dependable Walk-Ins & Blast Chillers

5800 SE 78th St. Ocala, FL 34472 • 352.245.7055 • service@americanpanel.com



Warranty3-4

Basic Safety Information..... 5

Equipment Tag..... 6

Pre-installation Checks..... 6

Installation 6

Reading the Floor Plan.....7

Preparing the Installation Site..... 7

Cam Lock Operation..... 8

Tools Needed..... 8

Components9-10

Unit Assembly..... 10-15

Specifications & Performance 16

Check for Proper Installation 16

Cycles & Modes Explained..... 17-19

Factory Presets 20

Unit Operation 21

 - Home Screen 21

 - Automatic Mode Screen 22

 - Start a Cycle in Automatic Mode 23

 - Manual Mode Screen 24

 - Start a Cycle in Manual Mode 25

 - A La Carte Mode Screen 26

 - Start a Cycle in A La Carte Mode 27

 - Start a Cycle in Quick Start Mode 28

 - Customize the Quick Start Button 28

PC Connection Package 29

Connect to Controller - Direct Connection..... 29

Connect to Controller - WiFi 30-31

Connect to Controller - WiFi Notification Setup 32

HACCP Download via USB 32

HACCP Download via Peer to Peer 33

HACCP Download via WiFi 33

Customizing the Cycles 34-35

General Operating Instructions..... 36

Maintenance Instructions..... 36

Contacts and Information

Customer service - +1(800) 327-3015 or +1(352) 245-7055

Service department. - service@americanpanel.com

Parts department. - parts@americanpanel.com

Website - www.americanpanel.com

For all blast chiller information requests, please have the Model and Serial Number available as stated on the equipment tag (pg 6) on the exterior of the cabinet.



American Panel HURRiCHiLL Blast Chiller/Shock Freezer Warranty

American Panel Corporation products are warranted to the original user installed within the United States, Canada and Puerto Rico to be free from defects in material or workmanship under normal and proper use, as outlined in the HURRiCHiLL owner’s manual and maintenance service specifications provided by American Panel.

The warranty period begins on the date of installation or 30 days from the date of product shipment from American Panel Corporation, whichever comes first. For this warranty to be in effect, the installation checklist/registration must be accurately completed and emailed to service@americanpanel.com within 72 hours from the installation or start-up date.

NOTE: This Warranty does not apply to altered or misused parts.

Self-Contained Units		
WARRANTY COVERS	PARTS	LABOR
Cabinet Assembly	3 Year from date of shipment	3 Year from date of shipment
Refrigeration Components	3 Year from date of shipment	3 Year from date of shipment
Refrigeration Compressor	5 Years from date of shipment	3 Year from date of shipment
Food Temperature Probes & Lights	None	None
Remote Refrigeration Units		
Cabinet Assembly	3 Year from date of shipment	3 Year from date of shipment
Refrigeration Components	3 Year from date of shipment	None
Refrigeration Compressor	5 Years from date of shipment	None
Food Temperature Probes & Lights	None	None

Note: Refrigeration compressor warranty is valid for one time replacement.

This warranty is not assignable and applies only valid to the original purchaser/user to whom delivered. Any such assignment or transfer shall void the warranties herein made and shall void all warranties, express or implied, including any warranty of merchantability or fitness for a particular purpose. There aren’t any other warranties expressed, implied or statutory, except the warranties as described above.

American Panel Corporation agrees to repair or replace at its option, FOB Factory, any part which proves to be defective due to defects in material or workmanship during the warranty period, providing the equipment has been properly installed, maintained and operated in accordance with the HurriChill™ User’s Manual. Refer to the above chart for details and exceptions for various equipment items. Labor covered by this warranty must be authorized by American Panel Corporation and performed by a factory authorized service agency or factory preferred service company. Contact American Panel Corporation for a list of agents in your area.

This warranty does not apply to remote or pre-assembled remote refrigeration systems requiring electrical inter-wiring or refrigerant piping provided by others. American Panel Corporation reserves the right to withdraw this warranty if it is determined that equipment is not being operated or maintained properly per the HURRiCHiLL operations manual .



WHAT IS NOT COVERED BY THIS WARRANTY

This warranty does not apply to:

- Any aesthetic components
- Door Gaskets
- Bulbs, Condenser Filters, Food Probes, Damaged or Misused Probes
- Unit(s) moved from original installation site or location or during any shipping.
- Software update/parameter modification

American Panel will not assume:

- Responsibility for economic loss; profit loss or special indirect or consequential damages, including but not limited to, losses or damages arising from food or product spoilage claims, delayed installations or shipping, parts shortages, labor shortages or strikes.
- Liability for parts or labor coverage for component failure or other damages resulting from improper usage or installation or failure to clean and/or maintain product per the HURRICHiLL operations manual.
- Responsibility for the repair or replacement of any parts that American Panel determines have been subjected after the date of manufacture to alteration, neglect, abuse, misuse, accident, damage during transit or installation.
- Responsibility for the repair or replacement of failed or damaged components resulting from improper voltage feeds, electrical power failure, electrical storm or grid power surges, the use of extension cords, low voltage, or voltage drops or spikes to the unit.
- Responsibility for any damages caused during or at any storage facility including but not limited to, dealer and on/off site storage.

TRANSPORTATION DAMAGE AND CLAIMS

All American Panel equipment is sold FOB shipping point, and when accepted by the carrier, such shipments become the property of the consignee. Should damage occur in shipment, it is a matter between the carrier and consignee. In such cases, the carrier is assumed to be responsible for the safe delivery of merchandise, unless negligence can be established on the part of the shipper.

- Make an immediate inspection while equipment is still in the truck or immediately after it is moved to the receiving area.
- Do not sign a delivery receipt or freight bill until you have made a proper count and inspection of all merchandise received.
- Note all damage to packages directly on the carrier's delivery receipt.
- Make certain the driver signs this receipt. If he refuses to sign, make a notation of this refusal on the receipt.
- If the driver refuses to allow inspection, write the following on the delivery receipt, "Driver refuses to allow inspection of containers for visible damage".
- Save any packages and packing material for further inspection by the carrier.
- Promptly file a written claim with the carrier and attach copies of all supporting paperwork.

American Panel requires that the consignee unpack and fully inspect their unit(s) for any concealed freight damage. Any claims for concealed freight damaged must be reported to American Panel within 72 hours of receipt of shipment via email to traffic@americanpanel.com.

During the warranty period, all requests for service MUST be made before any work is begun. Such requests must be directed to American Panel Corporation Service Department, which will issue written authorization when applicable. Without this authorization, the Warranty may be voided. The service department can be contacted by mail at **American Panel Corp., 5800 S.E. 78th Street, Ocala, Florida 34472-3412**; by telephone at **1-800-327-3015**; by fax at **(352) 245-0726**; or via email at service@americanpanel.com.

Service department hours - **Monday - Friday 8am-5pm EST.**

American Panel will continue its policy of assisting our customers in collecting claims which have been properly filed and actively pursued. American Panel will not assume the responsibility of any claims nor accept deductions in payment for such claims.

**** Proper installation is the responsibility of the dealer, the owner-user, or the installing contractor. It is not covered by this warranty.**



Basic Safety Information

Do not touch or operate the machine with damp or wet feet and hands.

Do not insert screwdrivers, kitchen tools or other items between the protections and the moving parts.

Before carrying out cleaning operations or routine maintenance, disconnect the machine from the power supply mains, switching the master switch off and removing the plug.

If the power supply cable is damaged, it must be replaced by a service provider or similarly qualified staff, in order to avoid risks.

This unit must be equipped with a disconnection device incorporated in the fixed connection in compliance with local regulations.

When loading the machine, the use of kitchen gloves is recommended in order to prevent burns on contact with the hot trays and trolleys.

Use gloves suitable for trays and cold trolleys. During cleaning operations, of the condenser in particular, always wear protective gloves, safety glasses and mask for the respiratory protection.

- This manual is an integral part of the product, it supplies all of the indications necessary for correct installation, correct use and maintenance of the machine.
- It is mandatory for the user to read this manual carefully and always make reference to it. It must be kept in a place that is known and accessible to the authorized operators (installer, user, maintenance technician)
- The blast chiller is intended for professional use and therefore only qualified staff can use it
- The blast chiller is destined only for the use for which it has been designed.
- The manufacturer declines all responsibility for any damage caused by incorrect or unreasonable use, as for example:
 - improper use by untrained staff.
 - modification or interventions that are not specific for the model.
 - use of non-original spare parts or that are not specific for the model.
 - failure to comply, even partial, with the instructions in this manual.

The core probe must only be used for the purpose for which it has been designed: detect the temperature at the center of the food stuffs to be blast chilled and/or frozen.

It is prohibited to remove the protections and safety devices in order to perform routine maintenance.

Do not block the ventilation openings of the unit and of the structure in which it is positioned.



WARNING - Please read the entire installation procedure before attempting to install the unit. Failure to follow the procedures listed in this manual may result in voiding the warranty.



IMPORTANT - Due to the size and weight of this equipment, a minimum of two people are required to install this equipment safely. All OSHA regulations must be followed while on the job site.



- The manufacturer disclaims all responsibility for problems related to an incorrect installation of the blast chiller.
- The blast chiller must be installed by an authorized service/install provider.

Equipment Tag

The equipment tag is located on the exterior of the unit and displays the following information that is unique to the unit:

- Model Number
- Serial Number
- Refrigerant Charge
- Refrigerant Pressure (Low & High)
- Electrical Volts, Phase, Hertz and Amps
- Minimum Circuit Amps
- Maximum Fuse Size (Amps)

Please have this information on hand when contacting service or parts.

		5800 S.E. 78th STREET, OCALA, FL. 3447 FOR SERVICE CALL: 800-327-3015	
MODEL NO.		SERIAL NO.	
XXXXXXXX		XXXXXXXX	
REFRIGERANT:	<input type="text"/>	DESIGN PRESSURE (LOW):	<input type="text"/>
CHARGE IN OZ:	<input type="text"/>	DESIGN PRESSURE (HIGH):	<input type="text"/>
VOLTS:	<input type="text"/>	PH:	<input type="text"/>
		HZ:	<input type="text"/>
MINIMUM CIRCUIT AMPS:	<input type="text"/>	AMPS:	<input type="text"/>
		MAX FUSE SIZE:	<input type="text"/> A
		COMMERCIAL REFRIGERATOR AND/OR FREEZER 28E3	

Pre-installation Checks

- **Check components against the packing list. The packing list is located inside the accessory box.**
- **Check the integrity of the components once unpacked.**
- **Check for proper location**
 - Ambient temperature no greater than 90°F
 - Do not install near heat source
 - Do not install near vapor source
 - Do not install near grease source
 - Do not install in direct sun light
 - Do not install in closed areas with insufficient air change
- **Check for proper clearances**
 - 6" clearance on both sides of the unit
 - 15" clearance on top of the unit
 - 6" clearance to the back of the unit
 - 35.5" at the front of the unit for door opening
- **Check for unobstructed air flow at the condensing unit**

Installation

American Panel Corporation equipment has been shipped in a package designed to sufficiently protect from damage under normal shipping circumstances. Upon receiving the shipment, carefully inspect the package for visible damage and check the number of packages against the Bill of Lading. Notify the carrier immediately of any shortage or damage to your shipment. Claims must be filed promptly with the carrier.

After receipt of shipment, carefully and safely remove the unit from the package. Check the contents of the package against the packing list. Under no circumstances may a damaged piece of equipment be returned to American Panel Corporation without first obtaining written permission.

To assure proper installation carefully read and comply with the following instructions.

Reading the Floor Plan

Two floor plans are included with the unit. One will be located in the accessory box and the other will be attached to the exterior door and frame assembly. Below is a sample floor plan.

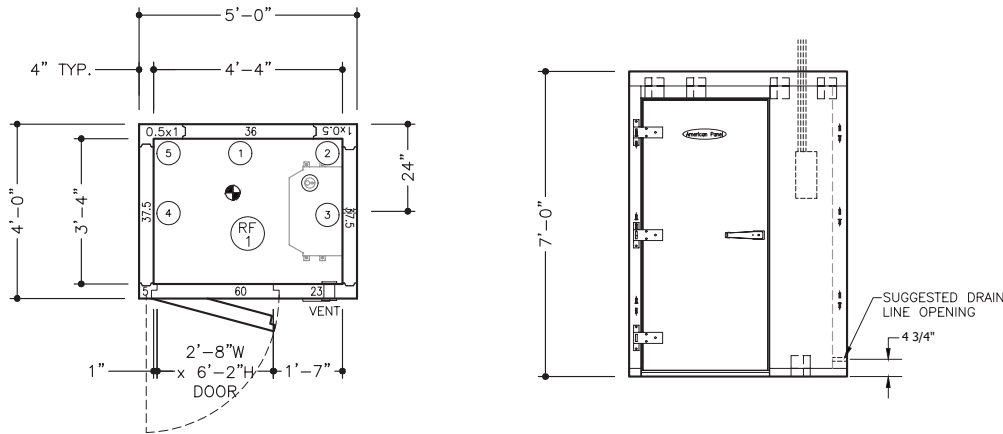

A review of the floor plan will indicate all dimensions, as well as all wall, ceiling floor and door locations. All wall, ceiling, floor and door/frame sections are numbered on the floor plan as well as on the corresponding equipment. All wall panels will have an arrow indicating which edge of the panel should be up. The floor plan is designed to help you easily and systematically install all components of the cabinet. For ease of installation always start with wall panel number one.

Preparing The installation Site

An overall inspection should be done of the installation area to familiarize oneself with potential problems such as building walls, ceilings, floors or concrete slabs. These items need to be considered when preparing the site. It is critical that the unit fits properly into the space provided.

PLEASE REVIEW THE FOLLOWING IN PREPARATION FOR INSTALLING THE UNIT:

- Note any offsets for building columns.
- Check condition of floor or slab (clean, smooth and level).
- Check height restrictions (ceiling, beams, duct work, lights, piping, etc.).
- Check location of floor drains and condensate lines.
- Check compliance with all building, electrical and mechanical codes.
- Verify that the door will open without restriction and does not obstruct frequent traffic patterns. The door should swing away from traffic flow when possible.
- Determine if panels of considerable length can be transported through door openings, hallways and stairways.
- Check and determine if the floor has been treated prior to installing the unit.
- Note the location of any special accessories (heated relief vents, alarms, etc.)

Cam-Lock Operation

The cam-lock locking device is located in the perimeter edge of all panels. Cam-Lock access holes are located on the interior side of the panels. Generally speaking the male locks are located on the right side, top and bottom of the wall panels.

The cam action of the lock will pull the panels together, compressing the factory applied gasket and providing an air tight seal.

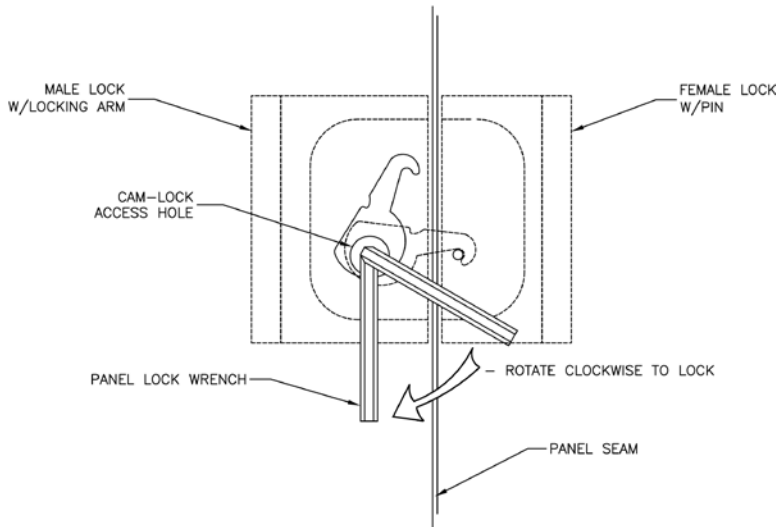

To operate the cam-lock, (as shown) insert the panel lock wrench (located in the accessory box) through the lock access hole and into the hex opening in the male cam-lock.

Turn the panel lock wrench counter clockwise to check that the locking arm is brought to a completely open position.

Next, rotate the panel lock wrench clockwise 3/4 of a full turn to actuate the lock engaging the locking arm to the lock pin. The cam action of the lock will pull the panels together, compressing the factory applied gaskets and providing an air tight seal.

Finally, rotate the panel lock wrench approximately 1/4 turn to fully actuate the lock by securing the cam-lock arm to the pin. Once all the cam-locks are engaged, the access holes must be plugged with the supplied lock hole buttons (located in the accessory box).

Male and female cam-lock mechanisms must line-up on adjacent panels, but are able to tolerate a +/- 1/8" tolerance. Continually check to see that the tops of the adjacent panels are evenly lined up and flush before locking. Continually check to see that the interior seam of the panels being locked together is flush, tolerance is +/- 1/64".

Tools Needed

Have these tools available for the installation of the AP20BCF200-3-XL.

- 5/16" Cam lock wrench (included in accessory box)
- Phillip head bit
- Tape measure
- Drill driver
- Adjustable wrench or
- 1 1/4" hole saw for stainless steel
- Refrigerant oil
- Level
- Insulation tape
- Leak sniffer or soapy solution
- Sockets :
 - 9/16" standard and deep well
 - 7/16"
 - 11/32"

Components

1. Evaporator Coil
2. Condensing Unit
3. Liquid Line
(packaged with Condensing Unit)
4. Suction Line
(packaged with Condensing Unit)
5. Floor Panel
6. Ceiling Panel
7. Door Panel
8. Corner Panel Left
9. Corner Panel Right
10. Wall Panel Left
11. Wall Panel Right
12. Back Panel
13. Drain Pan
14. Air Seal Long Side
(packaged with Condensing Unit)
15. Air Seal Short Side
(packaged with Condensing Unit)
16. Front Shroud
17. Left Side Shroud
18. Right Side Shroud

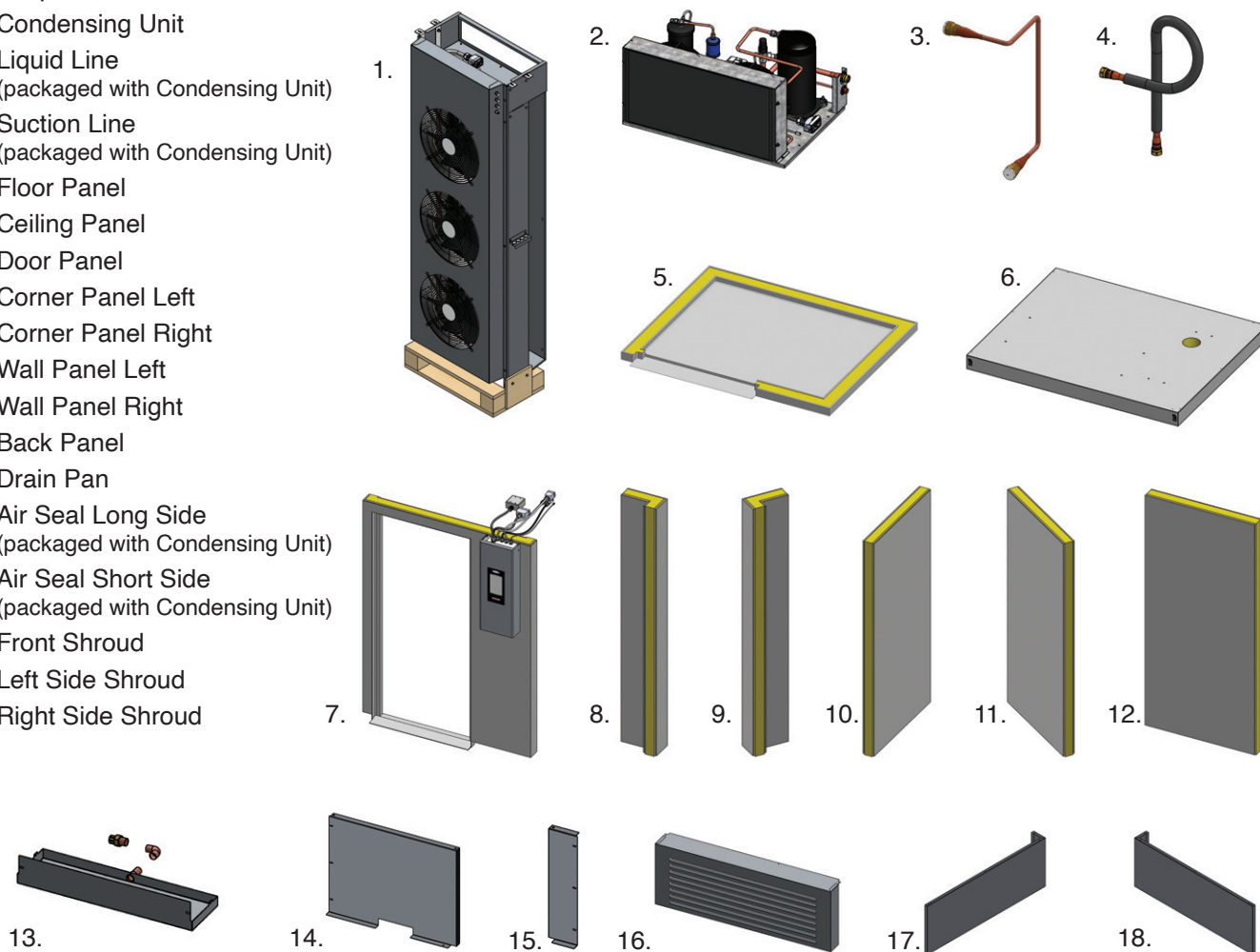

19) Evaporator Assembly Fasteners (packaged together)

- 4 pcs 3/8-16 x 7" Hex Head Bolts
- 4 pcs 3/8-16 Hex Nut
- 8 pcs 3/8 Flat Washer
- 8 pcs 3/8 Split Washer
- 4 pcs #10-24 x 3/4" Hex Head Washer Screws

20) Condensing Unit Fasteners (packaged together)

- 4pcs 1/4-20 x 1.5" Hex Head Bolts
- 4pcs 1/4" washers

21) Drain Pan Fasteners (packaged together)

- 2 pcs 10-24 x 3/4" Truss Head Screws
- 2 pcs 8-32 x 3/4" Truss Head Screws

22) Shroud Fasteners (packaged together)

- 15 pcs #8 Sheet Metal Screws
- 5 pcs 10-24 x 3/4" Hex Head Washer Screws

Components - *Continued*

23) Threshold Fasteners (packaged together)

- 4 pcs 10-24 x 3/8" Flat Head Screws

24) 1 can expandable foam

25) Stainless Steel Buttons - 45 pieces

26) 5/16" Cam Lock Wrench

27) Plan

Unit Assembly Instructions

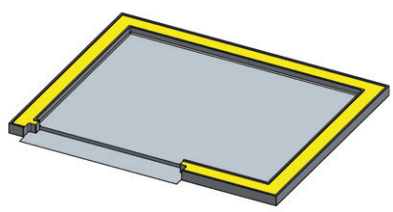
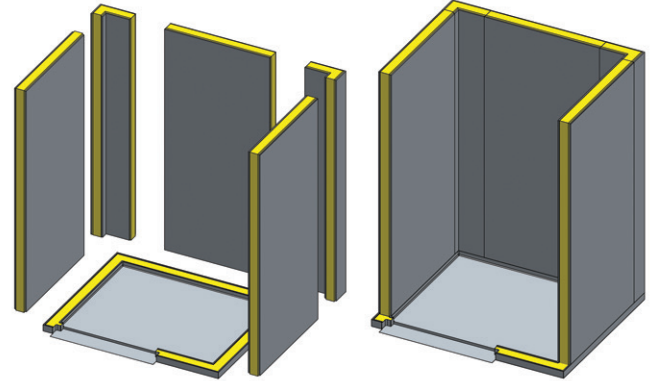
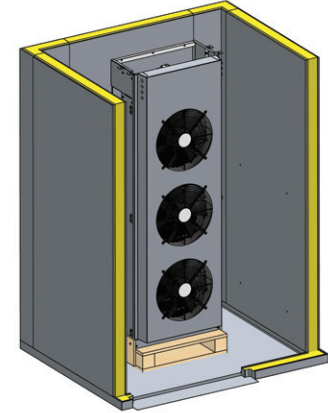

Step	Description	Diagram
------	-------------	---------

Unit Assembly

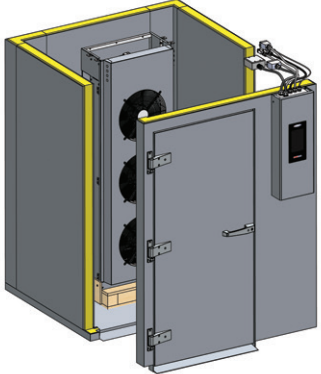
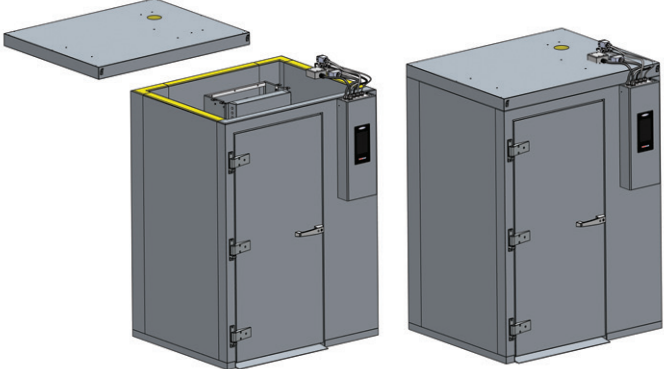
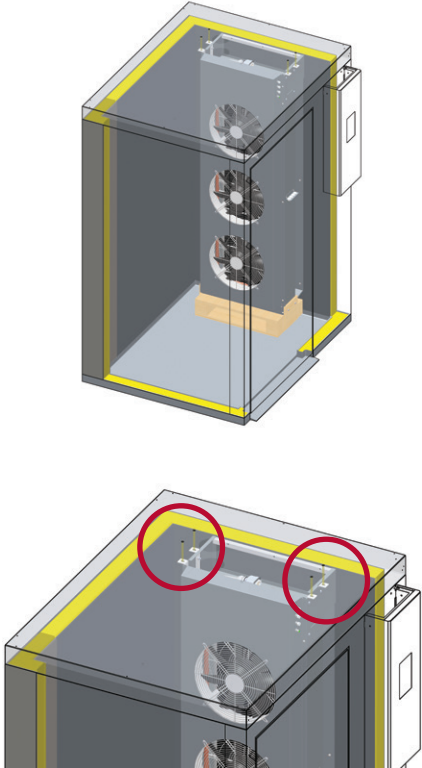

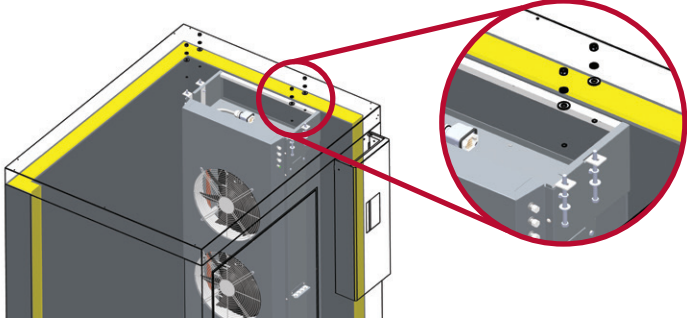
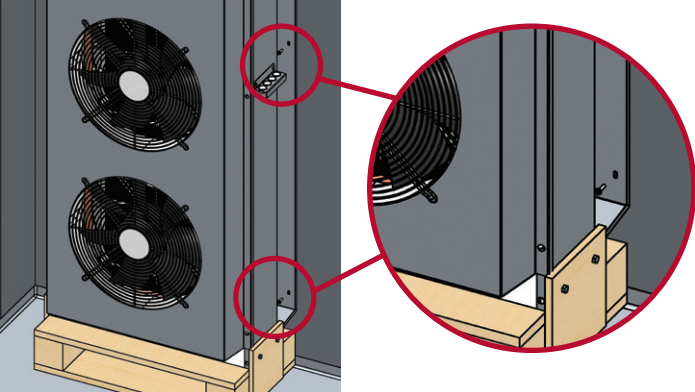
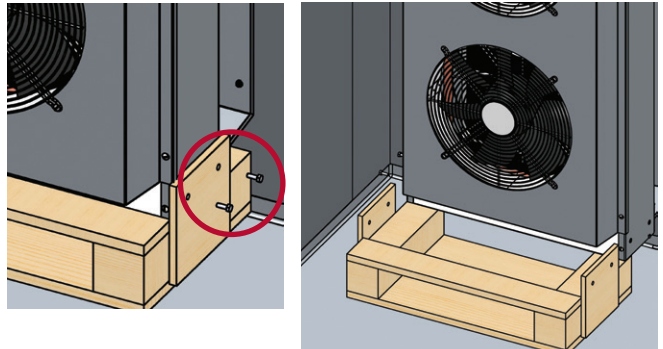
<p>1</p>	<p>Place and level the floor</p>	
<p>2</p>	<p>Assemble the wall and corner panels. Fasten all panels with integrated cam locks</p>	
<p>3</p>	<p>Place the evaporator assembly inside the unit. This is a temporary position to allow installing the door and the ceiling panels.</p>	

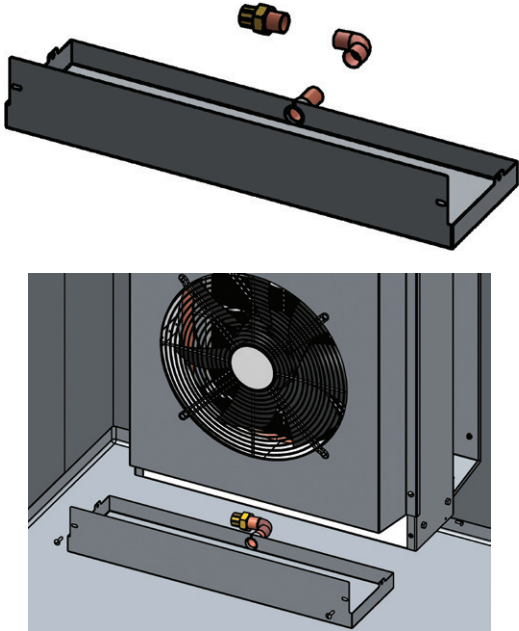
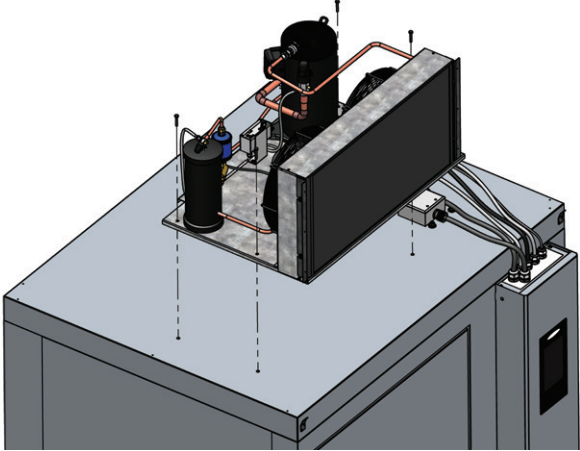
Step	Description	Diagram
4	Install and fasten the door panel.	
5	Place and fasten the roof panel.	
6	Position the evaporator assembly along the side wall, behind the side of the door with the controller. Align the top bracket slots to the mounting holes in the ceiling panel.	

Step	Description	Diagram
7	<p>Secure the evaporator to the ceiling panel using the provided hardware – 3/8" bolts, flat washers, split washers, and nuts. See hardware bag labeled "Evaporator Assembly Fasteners". Care should be taken when tightening the screws. Tighten each screw one turn at a time in a diagonal pattern to avoid damaging the screws.</p>	
8	<p>Secure the evaporator assembly to the back wall using the provided 10-24 hex head washer screws located inside the bag labeled "Evaporator Assembly Fasteners".</p>	
9	<p>Remove and discard the temporary wooden support frame, re-install the screws to cover the screw holes.</p>	

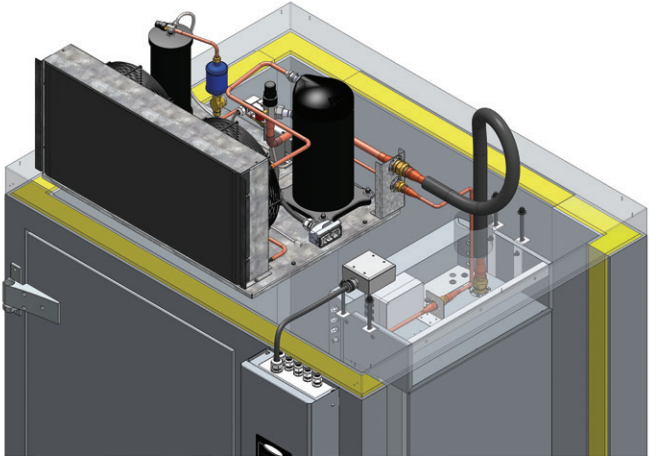
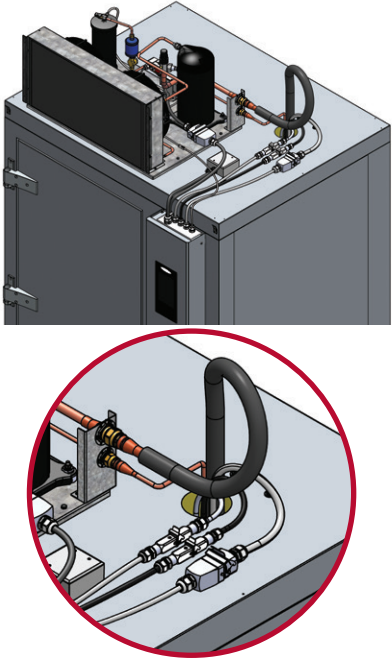
Step	Description	Diagram
10	<p>Install the drain pan. Use the two provided 10-24 x 3/4" truss head screws for the front holes and the two 8-32 x 3/4" truss head screws for the side holes. Route the drain line and connect the drain pan to it. When drilling the opening for the drain line through the panel, special precautions should be taken not to drill through a cam-lock. The edge of the lock extends 4.25" from the cam-lock access hole. When routing the drain-line the provided threaded union must be installed inside the cabinet to allow for drain pan removal and cleaning. The fasteners for the drain pan are located inside the corresponding fastener bag.</p>	
11	<p>Mount and secure the condensing unit to the ceiling panel. Use the 4pcs 1/4-20 x 1.5" hex head screws located in the bag labeled "Condensing Unit Fasteners".</p>	
	<p>Warning! <i>The weight of the condensing unit is 153 lbs use the appropriate manpower and the necessary tools to handle the condensing unit and place it on top of the cabinet.</i></p>	

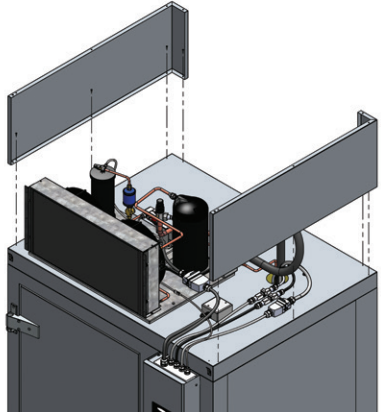
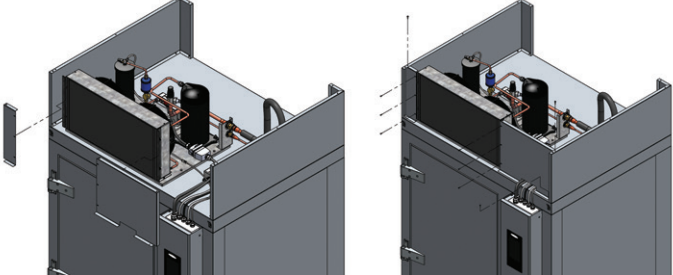
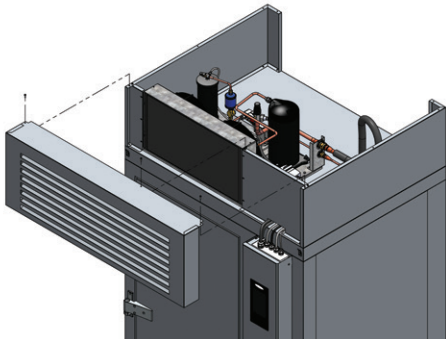
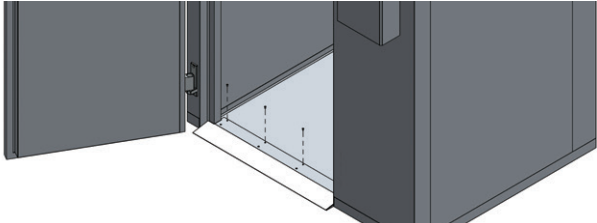
Step	Description	Diagram
12	<p>Connect the refrigeration lines.</p> <p>The condensing unit and the evaporator coil are factory pre-charged. The interconnecting suction and liquid lines (also pre-charged) are fitted with quick-connect, self-sealing refrigerant couplings, covered by protective caps (which should not be removed until ready for coupling).</p> <p>The couplings for the evaporator connection are located inside the evaporator enclosure, to gain access open the evaporator door (the sheet metal housing the fans).</p>	
<p>Coupling halves are connected by a hexagonal union nut using the following procedure:</p> <ol style="list-style-type: none"> Remove protective caps including black neoprene seal. Check caps carefully to ensure black seal is still in cap and has not been lodged in quick-connect coupling. Wipe all coupling seals and threaded surfaces clean to prevent inclusion of dirt or foreign matter in the system. Lubricate rubber seal in the male half with refrigerant oil. Thread couplings together halfway by hand to insure proper mating of threads. (Be careful not to cross thread the couplings). Tighten with proper wrenches until coupling bodies “bottom” or until a definite resistance is felt. Then tighten an additional 1/6 to 1/4 turn. All connections should be leak tested after tightening. Low side connections should be wrapped with insulation tape. 		
13	<p>Make the electrical connections. The interconnection cables between the controller, evaporator and condensing unit are all equipped with female and male plugs. Each connection has a specific connector to insure correct pairing. The connection cables for the evaporator are located inside the evaporator enclosure, to gain access open the evaporator door. Route the cables through the existing opening in the ceiling.</p>	

Step	Description	Diagram
14	<p>Install the side shrouds, observe the markings on the shrouds to know which side of the unit it mounts on. To secure the shrouds to the ceiling panel use 8 pcs of the sheet metal self tapping screws located inside the bag labeled “Shrouds Fasteners”. The mounting holes into the ceiling panel are pre-drilled.</p>	
15	<p>Mount the sides air seals, use 7 pcs of the provided sheet metal self tapping screws. To secure the side air seals to the side shrouds use 2 pcs of the 10-24 x 3/4” hex head washer screws. All screws are located inside the bag labeled “Shrouds Fasteners”.</p>	
16	<p>Mount and secure the front shroud, use the provided 3pcs 10-24 x 3/4” hex head washer screws. Note the cut out into the back of the front shroud, the cut-out must accommodate the retaining clips mounted on the ceiling panel.</p>	
17	<p>Secure the threshold plate to the interior floor sheet metal. Fasten the door threshold plate to the floor metal using the supplied screws located inside the bag labeled “Threshold Fasteners”.</p>	
18	<p>Make the main power connection inside the 4x4 junction box directly connected to the controller via a cord, located on top of the unit and labeled “Main Power Connections”. The electrician to connect the unit to main power, observe the electrical requirements marked on the safety label located on the right side of the control panel.</p>	
	<p>Note: To ensure proper phase sequence at the scroll compressor, the unit is equipped with a phase monitor. If when powered the controller display does not light up reverse two of the phases inside the junction box labeled “Main Power Connections”.</p>	

Specifications and Performance

Blast chilling - AP20BCF200-3-XL can lower the temperature of 200 lbs. of food from 160°F to 38°F within 90 minutes.
Shock freeze - AP20BCF200-3-XL can lower the temperature of 120 lbs. of food from 160°F to 0°F within 300 minutes.



Note: *Overloading the unit could significantly reduce its service life.*

Check for Proper Installation

Perform the checks below to ensure optimal operating conditions and to maximize the service life of the equipment.

1. Check the integrity of the unit.
2. Check for proper location.
 - Ambient temperature no greater than 90°F (to ensure rated performance)
 - Must not be installed near heat source
 - Must not be installed near grease source
 - Must not be installed near vapor source
 - Must not be installed in direct sun light
 - Must not be installed in closed areas with insufficient air change
3. Check for proper clearances
 - 14" clearance for proper door operation if unit is adjacent to building wall (Models AP36).
 - 15" clearance above the unit for service
 - Provide enough space in front to allow door opening
 - Check for unobstructed air at the condensing unit
4. Check to ensure the unit is level.
5. Confirm the connected electrical service is in accordance with the manufacturer nameplate located on the unit.
6. Confirm that the installation of the refrigeration lines was done in accordance with the installation instructions in the previous chapter.
7. Check the installation of the drain pan and line and check for proper drainage.
8. Operate the unit in Hard Chill, Manual Mode for a few minutes to verify temperature pull-down.



NOTE: *American Panel Corporation blast chillers are equipped with a short cycle protection. If the unit is stopped or the door is opened and closed during a chilling cycle more than once, the compressor will not start for 3 minutes.*

9. Check liquid sight glass to be free of bubbles and dry.
10. Check functionality of evaporator and condenser fans.
11. Engage, operate, and verify effectiveness of manual defrost cycle.
12. Verify ozone sanitation (if so equipped) is functional.
13. Verify PC connection (if so equipped) is functional.
14. Inform the factory if any functional or performance issues were found following the above tests.

Modes Explained

Each unit is capable of running in either an ‘Automatic’, ‘Manual’ or ‘A la Carte’ mode:







- In ‘Automatic’ mode the unit will read the food temperature via the food probe and adjust the air temperature accordingly.





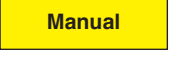

NOTE: When using ‘Automatic’ mode it is very important to insert the food probe in the product. The food probe must read the core temperature of the product in order for the unit to work as intended.

- In ‘Manual’ mode the air within the cabinet will be held at a preset temperature for a preset amount of time based on the selected operating cycle (see below).
- In ‘A la Carte’ mode the air within the cabinet will be held at a preset temperature until all of the timers expire.

Cycle	Description	Button (icon)
Soft Chill	Used for delicate items and salad items. Items with low fat or moisture content such as bakery goods should also use this mode.	
Auto	Automatic Mode: The air temperature will cycle between 28°F and 35°F until the food core temperature will reach 40°F, at this point the blast chiller will switch into holding mode where the air temperature will cycle between 35°F and 42°F until the food is removed from the cabinet and/or cycle is stopped by the operator.	
Manual	Manual Mode: The air temperature will cycle between 28°F and 35°F for 1.5 hours. After 1.5 hours the unit will switch into holding mode where the air temperature will cycle between 35°F and 42°F until the food is removed from the cabinet and/or cycle is stopped by the operator.	
A La Carte	A La Carte: The air temperature will cycle between 28°F and 35°F until all the timers expire, after that the unit will switch into holding mode where the air temperature will cycle between 35°F and 42°F until the cycle is manually stopped by the operator.	
Hard Chill	Used for all foods. Some freezing on the food surface may occur, especially with thicker products; if this is not acceptable use the ‘Soft’ cycle as described above.	
Auto	Automatic Mode: The air temperature will cycle between 0°F and 10°F until the food core temperature will reach 60°F (first part of the cycle). After the food core temperature reaches 60°F the air temperature inside the unit will cycle between 28°F and 35°F (second part of the cycle) until the food core temperature will reach 40°F. At this point the blast chiller will switch into holding mode where the air temperature will cycle between 35°F and 42°F until the food is removed from the cabinet and/or cycle is stopped by the operator.	
Manual	Manual Mode: The air temperature will cycle between 0°F and 10°F for one hour (first part of the cycle). After one hour the air temperature inside the unit will cycle between 28°F and 35°F for another hour (second part of the cycle). At this point the blast chiller will switch into holding mode where the air temperature will cycle between 35°F and 42°F until the food is removed from the cabinet and/or cycle is stopped by the operator.	
A La Carte	A La Carte: The air temperature will cycle between 0°F and 10°F until all the timers expire, after that the unit will switch into holding mode where the air temperature will cycle between 35°F and 42°F until the cycle is manually stopped by the operator.	

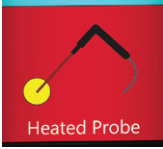
Cycle	Description	Button (icon)
Shock Freeze	Use for all freezing needs. When using the Shock Freezing Cycle the ice crystals that form within the product are very small. The quality and the texture of the product is preserved. For that reason, the Shock Freeze Cycle is suitable even for delicate products such as sushi meat and prime meat cuts. Shock Freeze Cycle will give excellent results when used in the process of Ice Cream and Gelato hardening, it will give a smooth texture to the product.	
	Automatic Mode: The air temperature will cycle between -20°F and -15°F until the food core temperature will reach 0°F, at this point the blast chiller will switch into holding mode where the air temperature will cycle between -4°F and 3°F until the food is removed from the cabinet and/or cycle is stopped by the operator.	
	Manual Mode: The air temperature will cycle between -20°F and -15°F for 4 hours. After 4 hours the unit will switch into holding mode where the air temperature will cycle between -4°F and 3°F until the food is removed from the cabinet and/or cycle is stopped by the operator.	
	A La Carte: The air temperature will cycle between -20°F and -15°F until all the timers expire, after that the unit will switch into holding mode where the air temperature will cycle between -4°F and 3°F until the cycle is manually stopped by the operator.	
	NOTE: <i>At the end of any cycle the unit will switch into holding mode to maintain the food at a specific temperature. However, the unit is not designed to be a refrigerator or holding cabinet. Do not allow the blast chiller to function in holding mode for extended periods of time.</i>	
Occasional overnight holding is allowed.		
Quick Start	The Quick Start mode allows for one button operation of the most common cycle as defined by the user. Quick Start is set from the factory as a Soft Chill - Manual mode but can be customized in the settings for any cycle operation.	

Cycle	Description	Button (icon)
Defrost	Use this mode to defrost the evaporator coil. The defrost cycle must be manually engaged (see controller operation below). Defrost the unit once a day or as needed. Ice build-up can be observed by looking thru the fan grill at the evaporator coil. The factory preset for the Defrost Cycle is 30 minutes.	
Thaw Cycle (if equipped)	Use to thaw frozen products. Units equipped with the Thaw feature will be delivered with a special thaw probe, a cordless drill and a sanitary drill bit. Use the cordless drill and sanitary drill bit to provide a hole to probe the frozen product.	
	Automatic Mode: The air temperature will cycle between 42°F and 50°F until the food temperature, as recorded by the thaw probe, will reach 32°F; at this point the blast chiller will switch into holding mode where the air temperature will cycle between 35°F and 42°F until the food is removed from the cabinet and/or cycle is stopped by the operator.	
	Manual Mode: The air temperature will cycle between 42°F and 50°F for a preset amount of time, set by the operator at the time of starting the cycle. After the cycle time expires, the unit will switch into holding mode where the air temperature will cycle between 35°F and 42°F until the food is removed from the cabinet and/or cycle is stopped by the operator.	
	NOTE: When probing for thaw cycle, use the drill bit to provide a hole in the frozen product.	
Heated Probe (if equipped)	Use the Heated Probe feature prior to extracting the temperature probe from the frozen product. Gentle heat will be applied to the food probe for 5 seconds to facilitate the extraction of the probe. The Heated Probe will run only if the temperature at the food probe is below 30°F. Repeat the heated probe cycle if needed.	
Sanitize (if equipped)		

Factory Presets Automatic Mode - Quick Reference Chart								
Cycle \ Setting	Low Air Part 1	High Air Part 1	Breaking Temp.	Low Air Part 2	High Air Part 2	End Food Temp.	Low Air Holding	High Air Holding
Soft	28°F	35°F	NA	NA	NA	40°F	35°F	42°F
Hard (Chillers Only)	10°F	20°F	60°F	28°F	35°F	40°F	35°F	42°F
Hard (Chillers & Freezers)	0°F	10°F	60°F	28°F	35°F	40°F	35°F	42°F
Shock Freeze	-20°F	15°F	NA	NA	NA	0°F	-4°F	3°F
Thaw	42°F	50°F	NA	NA	NA	32°F	35°F	42°F

Factory Presets Manual Mode - Quick Reference Chart								
Cycle \ Setting	Low Air Part 1	High Air Part 1	Time Part 1	Low Air Part 2	High Air Part 2	Time Part 2	Low Air Holding	High Air Holding
Soft	28°F	35°F	NA	NA	NA	90 Min	35°F	42°F
Hard (Chillers Only)	10°F	20°F	60 Min	28°F	35°F	60 Min	35°F	42°F
Hard (Chillers & Freezers)	0°F	10°F	60 Min	28°F	35°F	60 Min	35°F	42°F
Shock Freeze	-20°F	15°F	NA	NA	NA	300 Min	-4°F	3°F
Thaw	42°F	50°F	NA	NA	NA	Set at Start	35°F	42°F



Home Screen

The home screen can be accessed by tapping on the blank display, if the display is off, or by pressing the home button, if the controller is in one of the cycle screens.



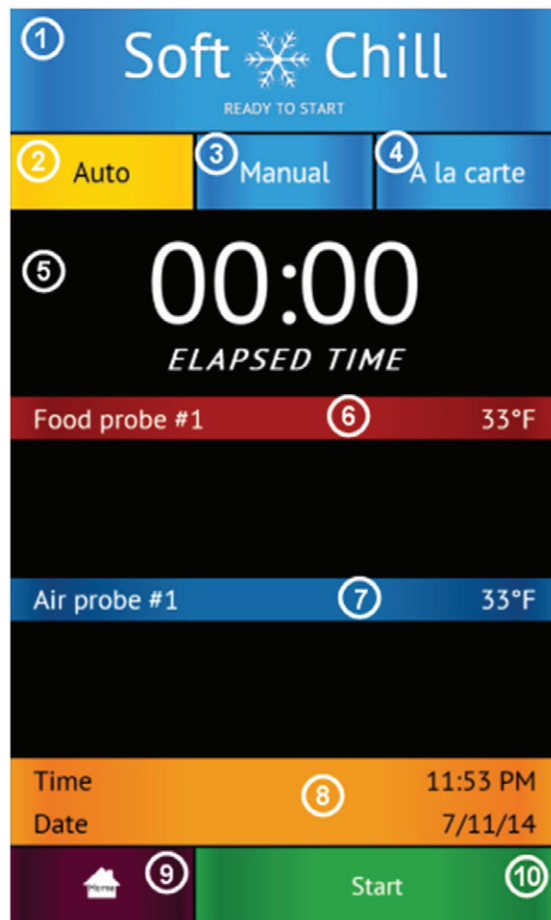

- 1) **Soft Chill Button** – Press to access Soft Chill Cycle Menu
- 2) **Hard Chill Button** – Press to access Hard Chill Cycle Menu
- 3) **Shock Freeze Button** – Press to access Shock Freeze Cycle Menu
- 4) **Quick Start Button** – Press to engage the preset cycle, the Quick Start Button is set from the factory to engage the Soft Chill cycle in Manual Mode. The operator can set the Quick Start Button to engage the desired cycle, see **Settings -> Quick Start**.
- 5) **Food Thaw Button** – Press to access Food Thaw Cycle Menu. Food Thaw Cycle is an optional cycle and is available on selected models only.
- 6) **Sanitize Button** – Press to access the Sanitize Cycle Menu. Sanitize Cycle is optional and is available on selected models only. Sanitize Cycle will sanitize the interior of the cabinet. Sanitize Cycle can be set to engage automatically at preset times of the day when unit not in use, see **Settings -> Sanitize**.
- 7) **Defrost Cycle Button** – Press to access the Defrost Cycle Menu. Defrost Cycle can be set to engage automatically at preset times of the day when unit not in use, see **Settings -> Defrost**.
- 8) **Reports Button** – Press to access the HACCP reports preview menu.
- 9) **Probe Heat Button** – Press to choose which food probe to heat for easier extraction from the frozen product.
- 10) **Settings Button** – Press to access the settings menu.

Automatic Mode Screen

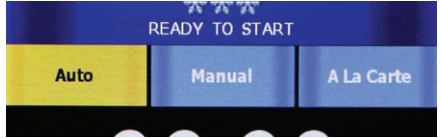
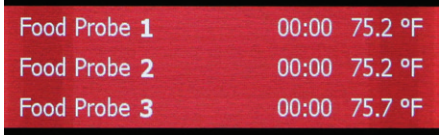

- 1) **Status Label** – Displays the selected cycle and the status of the cycle.
Status:
READY TO START – unit in standby mode waiting for the user to make a selection such as Start
CYCLE IN PROGRESS – the chilling cycle is in progress
COMPLETED – the chilling cycle has been completed and the unit is maintaining the product at safe holding temperatures
- 2) **Auto Mode Button** – Press to select the automatic blast chilling mode.
- 3) **Manual Mode Button** – Press to switch to the manual blast chilling mode.
- 4) **A la carte Mode Button** – Press to switch to the A la carte blast chilling mode.
- 5) **ELAPSED TIME Label** – Displays the elapsed time form the start of the cycle.
- 6) **Food probe #... Label/Button** – Press to assign to the current probe the food ID that it monitors. The assigned food ID will show on the HACCP reports. The label of Food probe #... will display the temperature of the probe. One food probe is the standard configuration for all American Panel Corporation blast chillers, the controller supports up to 4 food probes.
- 7) **Air probe #... Label** – Displays the air temperature inside the cabinet. Double and triple depth cabinet models will have two and three air probes respectively, one for each cabinet.
- 8) **Time and Date Label** – Displays the current date and time.
- 9) **Home Button** – Press to stop the current cycle and switch to the home screen.
- 10) **Start/Stop Button** – Press to start or stop the cycle. If the stop button will be pressed during the cycle a confirmation screen will prompt the user to confirm the choice.

How to Start a Cycle in Automatic Mode

Step	Description	Action									
1	Choose Soft Chill, Hard Chill or Shock Freeze from the Home screen										
2	Make sure Auto tab is selected <i>(For the Auto mode to work as intended the food probe must be inserted into the product)</i>										
3	Optional: press Food Probe # to assign a Food ID to the Probe. Choose from a set list of Food IDs or enter your own name.	 <table border="1" data-bbox="1073 905 1511 1041"> <tr> <td>Food Probe 1</td> <td>00:00</td> <td>75.2 °F</td> </tr> <tr> <td>Food Probe 2</td> <td>00:00</td> <td>75.2 °F</td> </tr> <tr> <td>Food Probe 3</td> <td>00:00</td> <td>75.7 °F</td> </tr> </table>	Food Probe 1	00:00	75.2 °F	Food Probe 2	00:00	75.2 °F	Food Probe 3	00:00	75.7 °F
Food Probe 1	00:00	75.2 °F									
Food Probe 2	00:00	75.2 °F									
Food Probe 3	00:00	75.7 °F									
4	Press start to start the cycle										

Manual Mode Screen

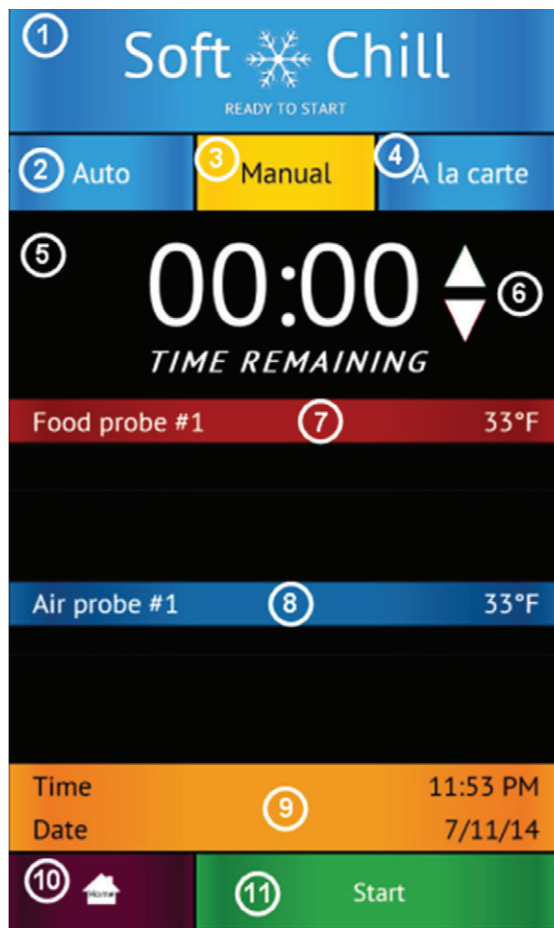

- 1) **Status Label** – Displays the selected cycle and the status of the cycle

Status:



READY TO START – unit in standby mode waiting for the user to make a selection such as Start

CYCLE IN PROGRESS – the chilling cycle is in progress

COMPLETED – the chilling cycle has been completed and the unit is maintaining the product at safe holding temperatures

- 2) **Auto Mode Button** – Press to select the automatic blast chilling mode.
- 3) **Manual Mode Button** – Press to switch to the manual blast chilling mode.
- 4) **A la carte Mode Button** – Press to switch to the A la carte blast chilling mode.
- 5) **TIME REMAINING Label** – Indicates the remaining time to the end of the cycle.
- 6) **UP/DOWN BUTTONS** – Press to adjust the cycle time as needed.
- 7) **Food probe #... Label/Button** – Press to assign to the current probe the food ID that it monitors. The assigned food ID will show on the HACCP reports. The label of Food probe #... will display the temperature of the probe. One food probe is the standard configuration for all American Panel Corporation blast chillers, the controller supports up to 4 food probes.
- 8) **Air probe #... Label** – Displays the air temperature inside the cabinet. Double or triple depth cabinet models will have two or three air probes respectively, one for each cabinet.
- 9) **Time and Date Label** – Displays the current date and time.
- 10) **Home Button** – Press to stop the current cycle and switch to the home screen.
- 11) **Start/Stop Button** – Press to start or stop the cycle. If the stop button will be pressed during the cycle a confirmation screen will prompt the user to confirm the choice.

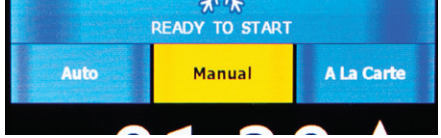
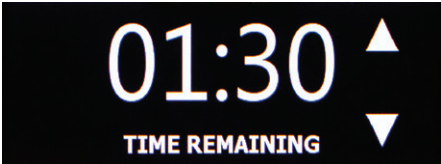
How to Start a Cycle in Manual Mode

Step	Description	Action									
1	Choose Soft Chill, Hard Chill or Shock Freeze from the Home screen										
2	Make sure Manual tab is selected										
3	Optional: Press up or down on the time arrows to adjust the cycle time										
4	Optional: press Food Probe # to assign a Food ID to the Probe. Choose from a set list of Food IDs or enter your own name.	 <table border="1" data-bbox="1073 1062 1511 1199"> <tr> <td>Food Probe 1</td> <td>00:00</td> <td>75.2 °F</td> </tr> <tr> <td>Food Probe 2</td> <td>00:00</td> <td>75.2 °F</td> </tr> <tr> <td>Food Probe 3</td> <td>00:00</td> <td>75.7 °F</td> </tr> </table>	Food Probe 1	00:00	75.2 °F	Food Probe 2	00:00	75.2 °F	Food Probe 3	00:00	75.7 °F
Food Probe 1	00:00	75.2 °F									
Food Probe 2	00:00	75.2 °F									
Food Probe 3	00:00	75.7 °F									
5	Press start to start the cycle										

A La Cart Mode Screen & Timer Screen

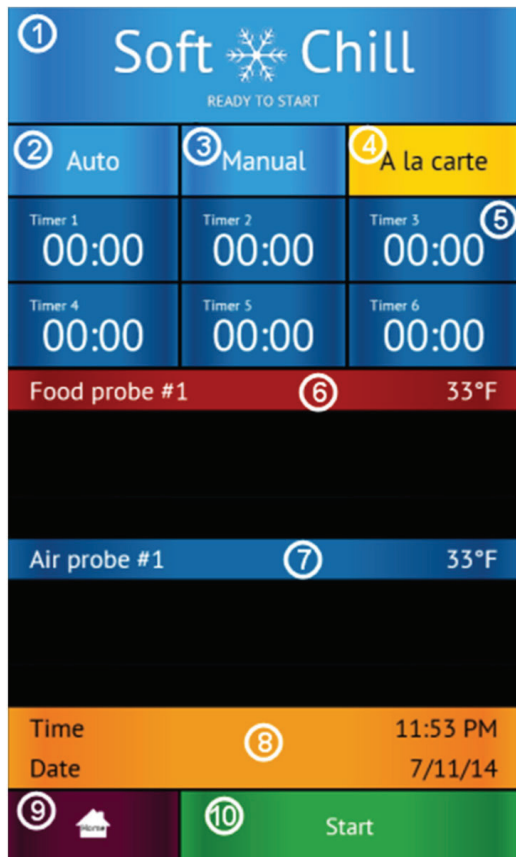

- 1) **Status Label** – Displays the selected cycle and the status of the cycle

Status:





READY TO START – unit in standby mode waiting for the user to make a selection such as Start

CYCLE IN PROGRESS – the chilling cycle is in progress

COMPLETED – the chilling cycle has been completed and the unit is maintaining the product at safe holding temperatures

- 2) **Auto Mode Button** – Press to select the automatic blast chilling mode.
- 3) **Manual Mode Button** – Press to switch to the manual blast chilling mode.
- 4) **A la carte Mode Button** – Press to switch to the A la carte blast chilling mode.
- 5) **Timer Buttons/Labels** – Press to access the timer setting screen. The timer label will indicate the remaining time and the product name of the food it monitors.
- 6) **Food probe #... Label** - The label of Food probe #... will display the temperature of the probe. One food probe is the standard configuration for all American Panel blast chillers, the controller supports up to 4 food probes.
- 7) **Air probe #... Label** – Displays the air temperature inside the cabinet. Double or triple depth cabinet models will have two or three air probes respectively, one for each cabinet.
- 8) **Time and Date Label** – Displays the current date and time.
- 9) **Home Button** – Press to stop the current cycle and switch to the home screen.
- 10) **Start/Stop Button** – Press to start or stop the cycle. If the stop button will be pressed during the cycle a confirmation screen will prompt the user to confirm the choice.
- 11) **Set Timer Id Button** – Press to assign a food id. to the current timer.
- 12) **Up/Down Buttons** – Press to adjust the timer.

How to Start a Cycle in A La Cart Mode

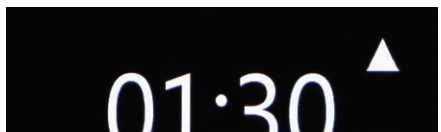
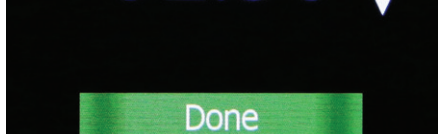
Step	Description	Action
1	Choose Soft Chill, Hard Chill or Shock Freeze from the Home screen	
2	Make sure A la carte tab is selected	
3	Select any available timer. Available timers are the ones set at 00:00 and have not yet been activated.	
4	Optional: Press Food ID to assign a Food ID to the timer. Choose from a preset list of IDs or enter your own.	
5	Press up or down on the time arrows to adjust the cycle time	
6	Press Done to start the cycle	
	Up to 6 timers can be added in the A la carte mode.	

How to Start a Cycle in Quick Start Mode & Customizing Quick Start

The Quick Start mode allows for one button operation of the most common cycle as defined by the user. Quick Start is set from the factory as a Soft Chill - Manual mode but can be customized in the settings for any cycle operation.

Press the Quick Start button to engage the preset cycle

To customize the Quick Start button, follow the steps below.



Step	Description	Action
1	To customize the cycle and mode that the Quick Start button engages, select Settings from the home screen and then Quick Start.	
2	Select the Cycle (Soft Chill, Hard Chill or Shock Freeze)	
3	Select the Mode (A la cart, manual or automatic)	
4	Enter a product name (Optional) from a list of items, or enter your own on the screen.	
5	Select Done to save your settings.	

PC Connection Package

The optional wireless pc communication package features:

- HACCP data download via local Wi-Fi network or peer-to-peer connection
- Remote blast chiller monitoring via Wi-Fi network
- E-mail notifications

Connect to Controller - Direct Connection



The optional wireless pc communication package is required to connect to the controller.

The controller is set from the factory as a Wi-Fi access point. In this configuration the controller broadcasts an SSID such as blast-chiller-xxxxxxxxx-wha.

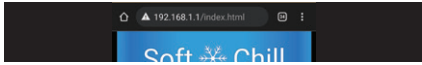
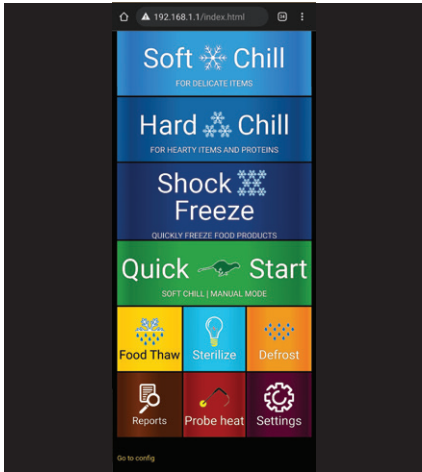
Step	Description	Action
1	Open the Wi-Fi connections on the device you want to use to access the controller	
2	Connect to the SSID of the unit - blast-chiller-xxxxxxxxx-wha is the SSID that is set from the factory. If this has been previously customized, use the current SSID in the system.	
3	Open a web browser on the device and enter 192.168.1.1 into the address bar.	
4	The home screen of the controller should show up in the browser window. You are now able to download HACCP data, monitor the blast chiller modes and set up any notification settings.	

Connect to Controller - Wi-Fi



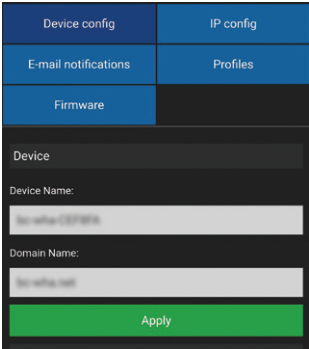
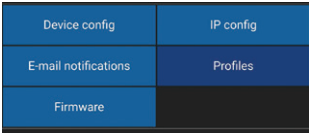
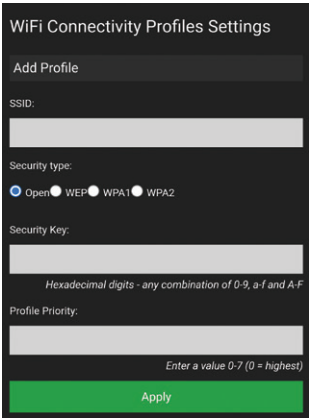

The optional wireless pc communication package is required to connect to the controller.

The controller is set from the factory as a Wi-Fi access point. In this configuration the controller broadcasts an SSID such as blast-chiller-xxxxxxxxxx-wha.

Step	Description	Action
1	Connect to the controller through the Direct Connection steps outlined on pg 28. Once connected on a browser, complete the steps below	
2	Press the “Go to config” button at the bottom of the screen.	
3	Make sure the “Device config” tab is selected Enter the desired name for your HURRiCHiLL device.	
4	Select the “Profiles” tab	
5	Enter the SSID for your wi-fi network Choose the correct security type for your network Enter your network security key (password) Enter 0 in Profile Priority Click the “Apply” button to save all the changes Click the “Go to application” button to go back to the main screen.	
6	Reset power to the unit and allow few minutes for the controller to connect to the Wi-Fi network.	

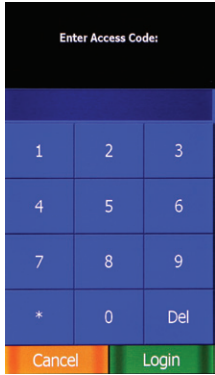

Connect to Controller - Wi-Fi *continued*

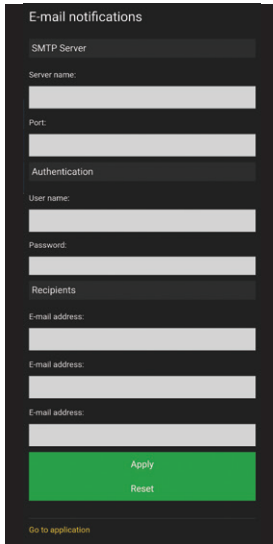
Step	Description	Action
7	Once the unit has restarted, Check the wi-fi settings by selecting the Settings button on the home screen of the unit.	
8	Enter the controller password and hit done	
9	Press the PC button to access the wi-fi settings	
10	Press the Wi-Fi Configuration button	
11	<p>A list of settings will be shown including Name, SSID it is connected to and IP Address.</p> <p>Your unit is now set up for wireless access.</p>	

Connect to Controller - Wi-Fi notifications setup

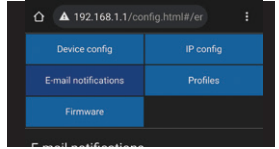
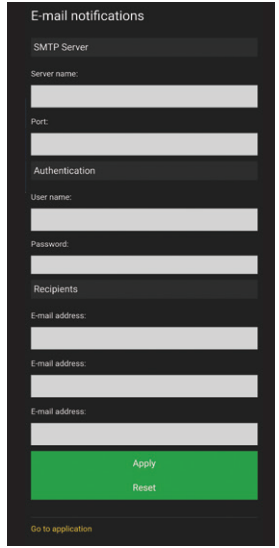
Step	Description	Action
1	Connect to the controller through the Direct Connection steps outlined on pg 28. Once connected on a browser, complete the steps below	
2	Press the “Go to config” button at the bottom of the screen.	
3	Make sure the “Email Notifications” tab is selected	
4	Enter the info for the fields below: <ul style="list-style-type: none"> • STP server name • Port type • Email address notifications will come FROM • Email account password • Email recipient - you can add up to 3 emails to send TO • Click “Apply” when done • Click “Go to Application” to exit 	

HACCP Data Download via USB

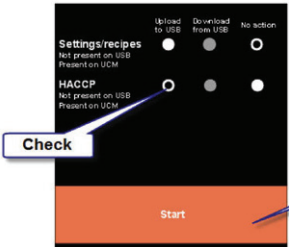

The optional USB pc communication package is required to connect to the controller.

Step	Description	Action
1	Insert a usb drive into the controller port shown.	
2	Check the settings on screen for the data needed.	
3	Press “Start” to download the file.	



HACCP Data Download via Peer to Peer

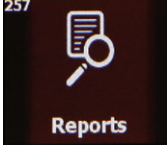
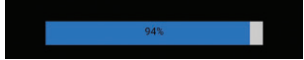
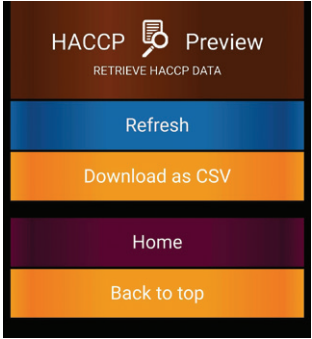

The optional wireless pc communication package is required to connect to the controller.

Step	Description	Action
1	Connect to the controller through the Direct Connection steps outlined on pg 28. Once connected on a browser, complete the steps below	
2	Press the “Reports” button on the home screen in your browser.	
3	Click Refresh to load the most current data. Wait until the refresh is complete - the bar will hit 100% and you will see the updated data on screen.	
4	Click the Download button to download the HACCP data as a CSV file to your device.	

HACCP Data Download via Wi-Fi



The optional wireless pc communication package is required to connect to the controller.

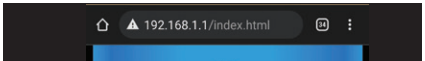
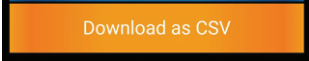





Step	Description	Action
1	Make sure the blast chiller is connected to a local wi-fi network as outlined on section “ Connect to Controller - Wi-Fi” Make note of the IP address of the machine. Connect the device to the same wi-fi network as the blast chiller.	
2	Enter the blast chiller IP address from step 1 into a browser on your device. This will connect to the unit over wi-fi and show the blast chiller home screen.	
3	Follow the steps in “HACCP Data Download via Peer to Peer” to download the data to your device.	

Customizing the Cycles and Technical Settings

Blast chilling and shock freezing cycles have been designed to deliver optimum chilling/freezing performance for most food products. If needed, all the cycles and settings can be customized via the settings menu and the screens below. Settings should only be changed by knowledgeable personnel or at the direction from a service technician.

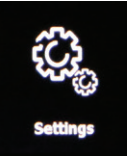
Setting	Description	Icon
Soft Chill	Temperature and timers settings for the Soft Chill cycle for each mode: Auto, Manual & A La Carte	 Soft Chill
Hard Chill	Temperature and timers settings for the Hard Chill cycle for each mode: Auto, Manual & A La Carte	 Hard Chill
Shock Freeze	Temperature and timers settings for the Shock Freeze cycle for each mode: Auto, Manual & A La Carte	 Shock Freeze
Quick Start	Customize the cycle, mode and product name used in the Quick Start button	 Quick Start
Defrost	Settings for: Length of Defrost, Auto Defrost, Auto Defrost Time, Cabinet Max Temp, Length of Auto Defrost	 Defrost
Date, Time, Language	Sets the time, date and language (English, French or Spanish) of the unit.	 Date, Time, Language
Thaw	Setts the Air Temp, Food Temp, Fan Settings and Duration for the Auto and Manual Food Thaw cycles.	 Thaw
Reports	HACCP reports settings: Date Interval, Notification Threshold, Capacity Disply, Capacity Alert, Clear Reports.	 Reports

Customizing the Cycles and Technical Settings - *Continued*

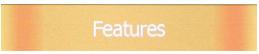
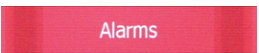
Setting	Description	Icon
Sanitize	Settings for: Length of Cycle, Auto Sanitation and Auto Sanitation Time.	
PC	Select the type of PC connection you use and see detailed info on the network settings.	
Home	Takes you back to the home screen	
Settings	Takes you to Technical Settings Screen - Optional Cycles, Temperature Probe(s) Setup, Contacts Setup, Features, Alarms, Brightness and Sound settings	 
	Optional Cycles - Choose additional non standard cycles	
	Probe Settings - Adjust probe temperatures and offsets	
	Contacts Settings - Settings for contact sensors in the unit.	
	Features - Technical features to be used by technician	
	Alarm Settings - Settings for all alarms	

General Operating Instructions

Panning and Loading

Follow the methods below for faster cooling, freezing and thawing:

- Place the food in shallow pans.
- Do not use food pans deeper than 2 ½" and do not fill the pan with more than 2" of product.
- Separate the food in smaller or thinner portions.
- Do not cover the containers unless danger of overhead contamination.
- Loosely cover the containers if necessary. Allow the cover material (aluminum foil) to touch the surface of the food.
- Arrange the pans for optimum air circulation within the cabinet.
- Know the capacity of the unit. Do not overload the unit.

Probing (for chilling and freezing cycles)

Follow the methods below to ensure correct probing of the product:

- Insert the food probe into the thickest part of the product.
- The tip of the food probe will have to be located at the core of the food.
- Always place the available food probe in the hardest to cool product.
- It is a good practice to restart the cycle every time food is added.
- Clean and sanitize the food probe after each use.

Probing (for optional Thaw cycle)

- Use the provided drill and drill bit to drill a hole into the frozen product.

Maintenance & Cleaning

Daily Maintenance

- Defrost the unit daily or as needed (pg 18).
- Wipe clean the interior and the exterior of the unit using a solution of mild soap and water.
- Wipe clean the door gasket.
- Engage the sanitation cycle (if equipped).

Quarterly Maintenance

The quarterly maintenance should be done by a service technician or by trained maintenance personnel.

- Inspect door hinge for proper operation.
- Inspect door gasket for proper seal.
- Inspect the drain line for proper flow.
- Use vacuum and brush to clean the condenser coil.
- Clean the evaporator coil.

Recommended Cleaning Solution

When cleaning the evaporator use only the cleaning agent listed below and follow the directions on the container for proper mixing and cleaning.

Enviro-Coil Concentrate Home Depot Supply

<http://www.hdsupplysolutions.com>

Part No: H-ECO1

Enviro-Coil Concentrate Hydro-Balance Corporation

Tel: (972) 394-9422





Versatile, Dependable Walk-Ins & Blast Chillers



American panel is your trusted manufacturer for all your cold storage, blast chilling and shock freezing needs. Building on a 60-year family owned and operated heritage, American panel provides versatile, dependable custom crafted walk-in coolers, freezers, combination cold rooms and blast chillers.

American Panel is proud to offer the largest line of blast chillers and shock freezers on the market. 37 different freestanding models and an infinite number of integral configurations. HURRiCHiLL offers the easiest to use controls in the industry, blast chilling is complex but controlling it doesn't have to be. American Panel is the go-to source for all your blast chilling/shock freezing needs.

Find out more at www.americanpanel.com