

# Installation & Operators Manual

Modular blast chillers & shock freezers

## MODELS COVERED:

AP20BC(F)

AP26BC(F)

AP36BC(F)

AP46BC(F)



*Please read this manual  
before installing or  
operation of this equipment.*



**Versatile, Dependable Walk-Ins & Blast Chillers**

5800 SE 78th St. Ocala, FL 34472 • 352.245.7055 • [service@americanpanel.com](mailto:service@americanpanel.com)



## Modular HURRiCHILL Installation & Operations Manual

Warranty .....	3-4
Basic Safety Information.....	5
Equipment Tag.....	6
Pre-installation Checks.....	6
Condensing Unit Installation.....	6
Electrical & Refrigeration Requirements.....	7
Installation .....	7
Reading the Floor Plan.....	8
Prepping the Installation Site.....	8
Cam Lock Operation.....	9
Tools Needed.....	9
Components .....	10
Unit Assembly.....	11-16
Units with Multiple Evaporators - Installation.....	17
Specifications & Performance .....	18
Check for Proper Installation .....	19
Cycles & Modes Explained.....	20-22
Factory Presets .....	23
Unit Operation .....	24
- Home Screen .....	24
- Automatic Mode Screen.....	25
- Start a Cycle in Automatic Mode.....	26
- Manual Mode Screen.....	27
- Start a Cycle in Manual Mode.....	28
- A La Carte Mode Screen.....	29
- Start a Cycle in A La Carte Mode.....	30
- Start a Cycle in Quick Start Mode.....	31
- Customize the Quick Start Button.....	31
PC Connection Package .....	32
Connect to Controller - Direct Connection.....	32
Connect to Controller - WiFi .....	33-34
Connect to Controller - WiFi Notification Setup.....	35
HACCP Download via USB.....	35
HACCP Download via Peer to Peer .....	36
HACCP Download via WiFi .....	36
Customizing the Cycles.....	37-38
Temperature Probe Adjustment.....	38
General Operating Instructions.....	39
Maintenance & Cleaning Instructions.....	40-41
Evaporator Coil Cleaning.....	42
Ozone Lamp Replacement Instructions .....	43

## Contacts and Information

**Customer service** - +1(800) 327-3015 or +1(352) 245-7055

**Service department.** - service@americanpanel.com

**Parts department.** - parts@americanpanel.com

**Website** - www.americanpanel.com

For all blast chiller information requests, please have the Model and Serial Number available as stated on the equipment tag (pg 5) on the exterior of the cabinet.



## American Panel HURRiCHiLL Blast Chiller/Shock Freezer Warranty

American Panel Corporation products are warranted to the original user installed within the United States, Canada and Puerto Rico to be free from defects in material or workmanship under normal and proper use, as outlined in the HURRiCHiLL owner’s manual and maintenance service specifications provided by American Panel.

The warranty period begins on the date of installation or 30 days from the date of product shipment from American Panel Corporation, whichever comes first. For this warranty to be in effect, the installation checklist/registration must be accurately completed and emailed to [service@americanpanel.com](mailto:service@americanpanel.com) within 72 hours from the installation or start-up date.

**NOTE: This Warranty does not apply to altered or misused parts.**

Self-Contained Units		
WARRANTY COVERS	PARTS	LABOR
Cabinet Assembly	3 Year from date of shipment	3 Year from date of shipment
Refrigeration Components	3 Year from date of shipment	3 Year from date of shipment
Refrigeration Compressor	5 Years from date of shipment	3 Year from date of shipment
Food Temperature Probes & Lights	None	None
Remote Refrigeration Units		
Cabinet Assembly	3 Year from date of shipment	3 Year from date of shipment
Refrigeration Components	3 Year from date of shipment	None
Refrigeration Compressor	5 Years from date of shipment	None
Food Temperature Probes & Lights	None	None

**Note: Refrigeration compressor warranty is valid for one time replacement.**

This warranty is not assignable and applies only valid to the original purchaser/user to whom delivered. Any such assignment or transfer shall void the warranties herein made and shall void all warranties, express or implied, including any warranty of merchantability or fitness for a particular purpose. There aren’t any other warranties expressed, implied or statutory, except the warranties as described above.

American Panel Corporation agrees to repair or replace at its option, FOB Factory, any part which proves to be defective due to defects in material or workmanship during the warranty period, providing the equipment has been properly installed, maintained and operated in accordance with the HurriChill™ User’s Manual. Refer to the above chart for details and exceptions for various equipment items. Labor covered by this warranty must be authorized by American Panel Corporation and performed by a factory authorized service agency or factory preferred service company. Contact American Panel Corporation for a list of agents in your area.

This warranty does not apply to remote or pre-assembled remote refrigeration systems requiring electrical inter-wiring or refrigerant piping provided by others. American Panel Corporation reserves the right to withdraw this warranty if it is determined that equipment is not being operated or maintained properly per the HURRiCHiLL operations manual .



## WHAT IS NOT COVERED BY THIS WARRANTY

### This warranty does not apply to:

- Any aesthetic components
- Door Gaskets
- Bulbs, Condenser Filters, Food Probes, Damaged or Misused Probes
- Unit(s) moved from original installation site or location or during any shipping.
- Software update/parameter modification

### American Panel will not assume:

- Responsibility for economic loss; profit loss or special indirect or consequential damages, including but not limited to, losses or damages arising from food or product spoilage claims, delayed installations or shipping, parts shortages, labor shortages or strikes.
- Liability for parts or labor coverage for component failure or other damages resulting from improper usage or installation or failure to clean and/or maintain product per the HURRiCHiLL operations manual.
- Responsibility for the repair or replacement of any parts that American Panel determines have been subjected after the date of manufacture to alteration, neglect, abuse, misuse, accident, damage during transit or installation.
- Responsibility for the repair or replacement of failed or damaged components resulting from improper voltage feeds, electrical power failure, electrical storm or grid power surges, the use of extension cords, low voltage, or voltage drops or spikes to the unit.
- Responsibility for any damages caused during or at any storage facility including but not limited to, dealer and on/off site storage.

## TRANSPORTATION DAMAGE AND CLAIMS

All American Panel equipment is sold FOB shipping point, and when accepted by the carrier, such shipments become the property of the consignee. Should damage occur in shipment, it is a matter between the carrier and consignee. In such cases, the carrier is assumed to be responsible for the safe delivery of merchandise, unless negligence can be established on the part of the shipper.

- Make an immediate inspection while equipment is still in the truck or immediately after it is moved to the receiving area.
- Do not sign a delivery receipt or freight bill until you have made a proper count and inspection of all merchandise received.
- Note all damage to packages directly on the carrier's delivery receipt.
- Make certain the driver signs this receipt. If he refuses to sign, make a notation of this refusal on the receipt.
- If the driver refuses to allow inspection, write the following on the delivery receipt, "Driver refuses to allow inspection of containers for visible damage".
- Save any packages and packing material for further inspection by the carrier.
- Promptly file a written claim with the carrier and attach copies of all supporting paperwork.

American Panel requires that the consignee unpack and fully inspect their unit(s) for any concealed freight damage. Any claims for concealed freight damaged must be reported to American Panel within 72 hours of receipt of shipment via email to [traffic@americanpanel.com](mailto:traffic@americanpanel.com).

During the warranty period, all requests for service MUST be made before any work is begun. Such requests must be directed to American Panel Corporation Service Department, which will issue written authorization when applicable. Without this authorization, the Warranty may be voided. The service department can be contacted by mail at **American Panel Corp., 5800 S.E. 78th Street, Ocala, Florida 34472-3412**; by telephone at **1-800-327-3015**; by fax at **(352) 245-0726**; or via email at [service@americanpanel.com](mailto:service@americanpanel.com).

Service department hours - **Monday - Friday 8am-5pm EST.**

American Panel will continue its policy of assisting our customers in collecting claims which have been properly filed and actively pursued. American Panel will not assume the responsibility of any claims nor accept deductions in payment for such claims.

**\*\* Proper installation is the responsibility of the dealer, the owner-user, or the installing contractor. It is not covered by this warranty.**



## Basic Safety Information

---

Do not touch or operate the machine with damp or wet feet and hands.

Do not insert screwdrivers, kitchen tools or other items between the protections and the moving parts.

Before carrying out cleaning operations or routine maintenance, disconnect the machine from the power supply mains, switching the master switch off and removing the plug.

If the power supply cable is damaged, it must be replaced by a service provider or similarly qualified staff, in order to avoid risks.

This unit must be equipped with a disconnection device incorporated in the fixed connection in compliance with local regulations.

When loading the machine, the use of kitchen gloves is recommended in order to prevent burns on contact with the hot trays and trolleys.

Use gloves suitable for trays and cold trolleys. During cleaning operations, of the condenser in particular, always wear protective gloves, safety glasses and mask for the respiratory protection.

- This manual is an integral part of the product, it supplies all of the indications necessary for correct installation, correct use and maintenance of the machine.
- It is mandatory for the user to read this manual carefully and always make reference to it. It must be kept in a place that is known and accessible to the authorized operators (installer, user, maintenance technician)
- The blast chiller is intended for professional use and therefore only qualified staff can use it
- The blast chiller is destined only for the use for which it has been designed.
- The manufacturer declines all responsibility for any damage caused by incorrect or unreasonable use, as for example:
  - improper use by untrained staff.
  - modification or interventions that are not specific for the model.
  - use of non-original spare parts or that are not specific for the model.
  - failure to comply, even partial, with the instructions in this manual.

The core probe must only be used for the purpose for which it has been designed: detect the temperature at the center of the food stuffs to be blast chilled and/or frozen.

It is prohibited to remove the protections and safety devices in order to perform routine maintenance.

Do not block the ventilation openings of the unit and of the structure in which it is positioned.



**WARNING** - Please read the entire installation procedure before attempting to install the unit. Failure to follow the procedures listed in this manual may result in voiding the warranty.



**IMPORTANT** - Due to the size and weight of this equipment, a minimum of two people are required to install this equipment safely. All OSHA regulations must be followed while on the job site.



- The manufacturer disclaims all responsibility for problems related to an incorrect installation of the blast chiller.
- The blast chiller must be installed by an authorized service/install provider.

## Equipment Tag

The equipment tag is located on the exterior of the unit and displays the following information that is unique to the unit:

- Model Number
- Serial Number
- Refrigerant Charge
- Refrigerant Pressure (Low & High)
- Electrical Volts, Phase, Hertz and Amps
- Minimum Circuit Amps
- Maximum Fuse Size (Amps)

Please have this information on hand when contacting service or parts.

		5800 S.E. 78th STREET, OCALA, FL. 3447 FOR SERVICE CALL: 800-327-3015	
MODEL NO.		SERIAL NO.	
XXXXXXXX		XXXXXXXX	
REFRIGERANT:	<input type="text"/>	DESIGN PRESSURE (LOW):	<input type="text"/>
CHARGE IN OZ:	<input type="text"/>	DESIGN PRESSURE (HIGH):	<input type="text"/>
VOLTS:	<input type="text"/>	PH:	<input type="text"/>
		HZ:	<input type="text"/>
MINIMUM CIRCUIT AMPS:	<input type="text"/>	AMPS:	<input type="text"/>
		MAX FUSE SIZE:	<input type="text"/> A
		COMMERCIAL REFRIGERATOR AND/OR FREEZER 28E3	

## Pre-installation Checks

- **Check components against the packing list. The packing list is located inside the accessory box.**
- **Check the integrity of the components once unpacked.**
- **Check for proper location**
  - Ambient temperature no greater than 90°F
  - Do not install near heat source
  - Do not install near vapor source
  - Do not install near grease source
  - Do not install in direct sun light
  - Do not install in closed areas with insufficient air change
- **Check for proper clearances**
  - 6" clearance on both sides of the unit
  - 15" clearance on top of the unit
  - 6" clearance to the back of the unit
  - 35.5" at the front of the unit for door opening
- **Check for unobstructed air flow at the condensing unit**

## Condensing Unit Installation

The condensing unit must be installed and connected in accordance with the installation manual provided with the condensing unit. The condensing unit and the cabinet must be connected to separate electrical power supply. When the condensing unit is provided by a third party, verify that rating meets the requirements listed above.

The blast chiller refrigeration system is of pump down type. The blast chiller controller will control the refrigeration by closing and opening the solenoid valve located inside the blast chiller cabinet. For proper operation, make sure the low pressure controller is set to cut out at 4 PSI and cut in at 15 PSI.

## Electrical & Refrigeration Requirements

Model	Cabinet Electrical	Cabinet Amp Draw	Refrigeration Type Required	Refrigeration BTU/H Required*
AP20BC-1T	208/60/1	8.2 A	Medium Temp	28,000
AP20BC-2T	208/60/1	15.5 A	Medium Temp	56,000
AP20BC-3T	208/60/1	22.7 A	Medium Temp	84,000
AP26BC-1T	208/60/1	8.2 A	Medium Temp	34,000
AP26BC-2T	208/60/1	15.5 A	Medium Temp	68,000
AP26BC-3T	208/60/1	22.7 A	Medium Temp	102,000
AP36BC-1T	208/60/1	8.2 A	Medium Temp	44,000
AP36BC-2T	208/60/1	15.5 A	Medium Temp	88,000
AP36BC-3T	208/60/1	22.7 A	Medium Temp	132,000
AP46BC-1T	208/60/1	8.2 A	Medium Temp	70,000
AP46BC-2T	208/60/1	15.5 A	Medium Temp	120,000
AP46BC-3T	208/60/1	22.7 A	Medium Temp	180,000
AP20BCF-1T	208/60/1	8.2 A	Medium/Low Temp	28,000
AP20BCF-2T	208/60/1	15.5 A	Medium/Low Temp	56,000
AP20BCF-3T	208/60/1	22.7 A	Medium/Low Temp	84,000
AP26BCF-1T	208/60/1	8.2 A	Medium/Low Temp	34,000
AP26BCF-2T	208/60/1	15.5 A	Medium/Low Temp	68,000
AP26BCF-3T	208/60/1	22.7 A	Medium/Low Temp	102,000
AP36BCF-1T	208/60/1	8.2 A	Medium/Low Temp	44,000
AP36BCF-2T	208/60/1	15.5 A	Medium/Low Temp	88,000
AP36BCF-3T	208/60/1	22.7 A	Medium/Low Temp	132,000
AP46BCF-1T	208/60/1	8.2 A	Medium/Low Temp	70,000
AP46BCF-2T	208/60/1	15.5 A	Medium/Low Temp	120,000
AP46BCF-3T	208/60/1	22.7 A	Medium/Low Temp	180,000

## Installation

American Panel Corporation equipment has been shipped in a package designed to sufficiently protect from damage under normal shipping circumstances. Upon receiving the shipment, carefully inspect the package for visible damage and check the number of packages against the Bill of Lading. Notify the carrier immediately of any shortage or damage to your shipment. Claims must be filed promptly with the carrier.

After receipt of shipment, carefully and safely remove the unit from the package. Check the contents of the package against the packing list. Under no circumstances may a damaged piece of equipment be returned to American Panel Corporation without first obtaining written permission.

To assure proper installation carefully read and comply with the following instructions.



## Cam-Lock Operation

The cam-lock locking device is located in the perimeter edge of all panels. Cam-Lock access holes are located on the interior side of the panels. Generally speaking the male locks are located on the right side, top and bottom of the wall panels.

The cam action of the lock will pull the panels together, compressing the factory applied gasket and providing an air tight seal.

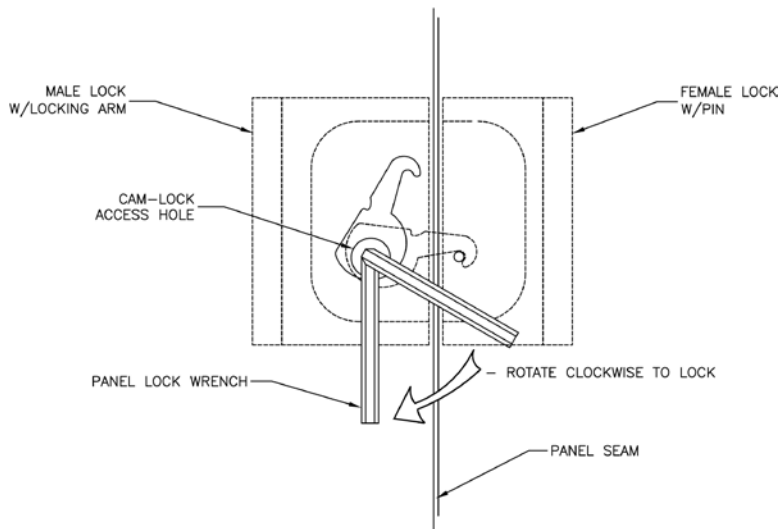

To operate the cam-lock, (as shown) insert the panel lock wrench (located in the accessory box) through the lock access hole and into the hex opening in the male cam-lock.

Turn the panel lock wrench counter clockwise to check that the locking arm is brought to a completely open position.

Next, rotate the panel lock wrench clockwise 3/4 of a full turn to actuate the lock engaging the locking arm to the lock pin. The cam action of the lock will pull the panels together, compressing the factory applied gaskets and providing an air tight seal.

Finally, rotate the panel lock wrench approximately 1/4 turn to fully actuate the lock by securing the cam-lock arm to the pin. Once all the cam-locks are engaged, the access holes must be plugged with the supplied lock hole buttons (located in the accessory box).

*Male and female cam-lock mechanisms must line-up on adjacent panels, but are able to tolerate a +/- 1/8" tolerance. Continually check to see that the tops of the adjacent panels are evenly lined up and flush before locking. Continually check to see that the interior seam of the panels being locked together is flush, tolerance is +/- 1/64".*

## Tools Needed

Have these tools available for the installation.

- 5/16" Cam lock wrench (included in accessory box)
- Tape measure
- Adjustable wrench or
- Refrigerant oil
- Insulation tape
- Sockets :
  - 9/16" standard and deep well
  - 7/16"
  - 11/32"
- Phillip head bit
- Drill driver
- 1 1/4" hole saw for stainless steel
- Level
- Leak sniffer or soapy solution

## Components

The component list below does not include the cabinet components such as door panel, floor panels, wall panels, etc.

### 1. Evaporator Coil

1 ea. for units with model number ending with "1T"

2 ea. for units with model number ending with "2T"

3 ea. for units with model number ending with "3T"

### 2. Electrical Panel

1 ea. / Blast Chiller

### 3. Center Air Deflector

1 ea. / Evaporator

### 4. Corner Air Deflectors

2 ea. / Evaporator

### 5. Condensate Diverter

1 ea. / Evaporator

### 6. Pipe & Bushing

1 ea. / Evaporator

### 7. Drain Pan

1 ea. / Evaporator - provided with 7/8" copper union

### 8. Misc. Hardware

Hex bolts for mounting the evaporator

Sheet metal screws

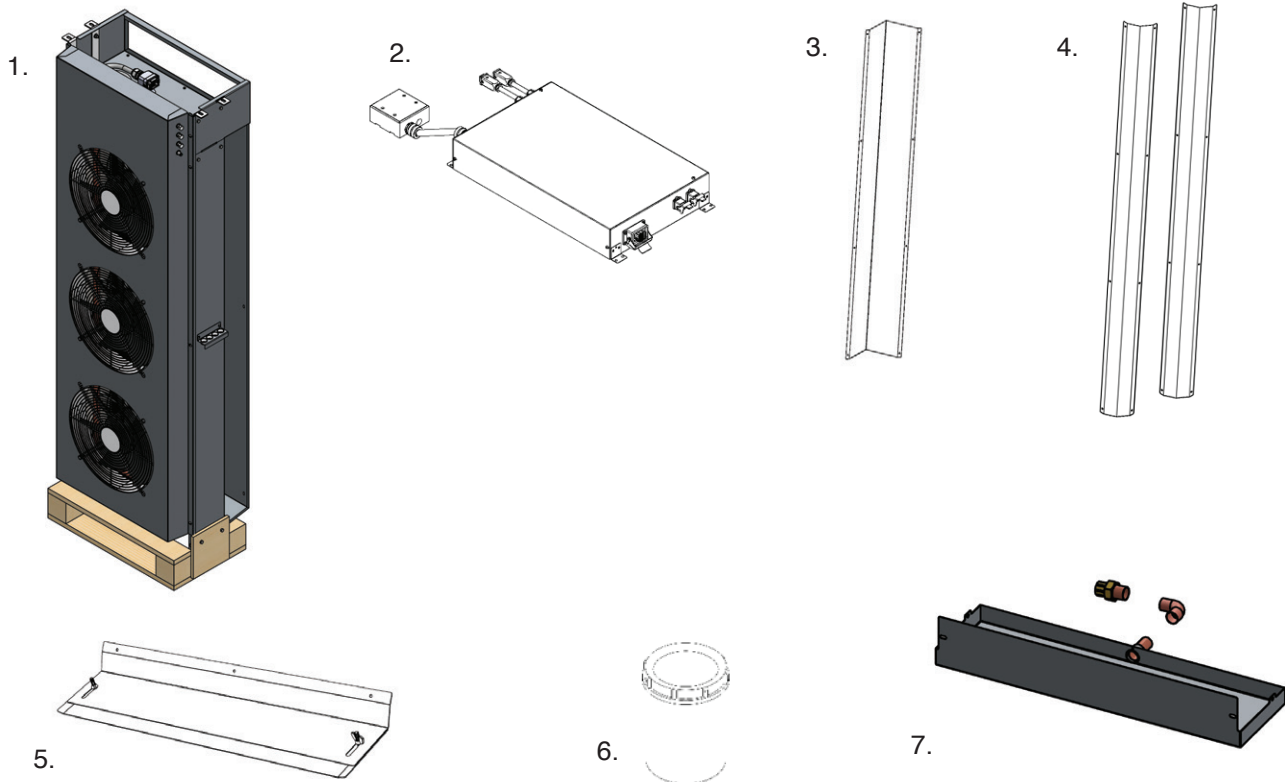

## Unit Assembly Instructions

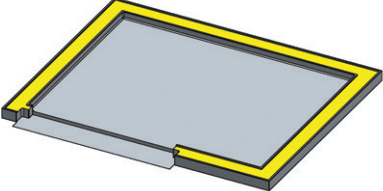
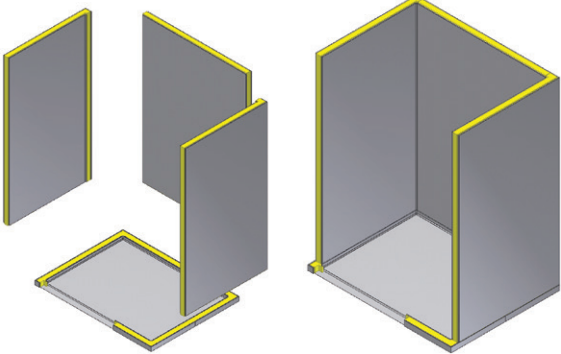
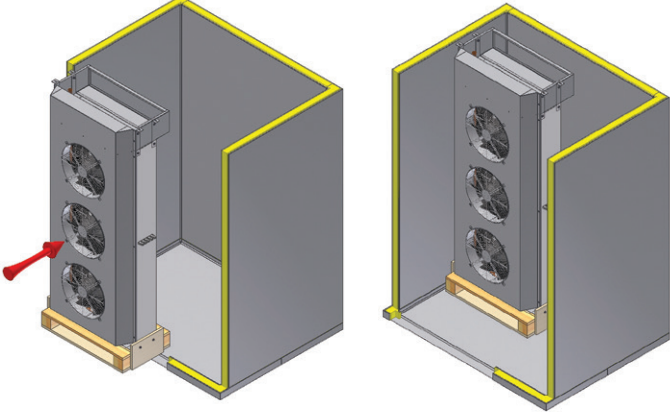
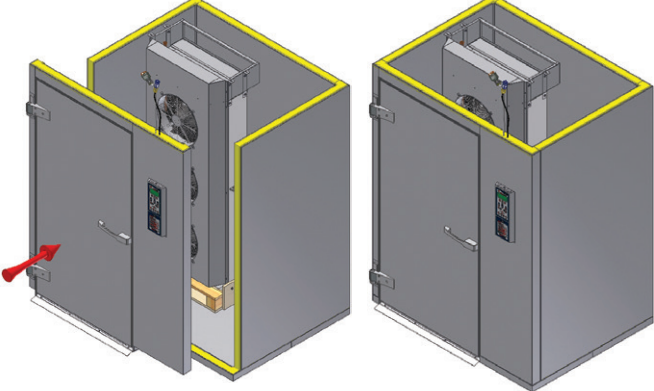
Step	Description	Diagram
<b>Unit Assembly</b>		
1	Place and level the floor	
2	Assemble the left, right and rear wall panels. Fasten panels to floor panel.	
3	Place the evaporator assembly inside the unit. This is a temporary position to allow installing the door and the ceiling panels.	
4	Install and fasten the door assembly to the walls and floor.	

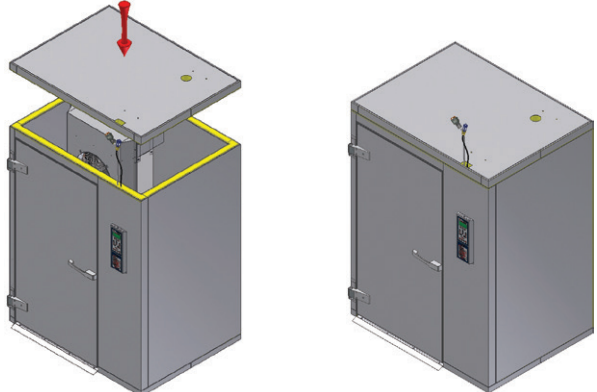
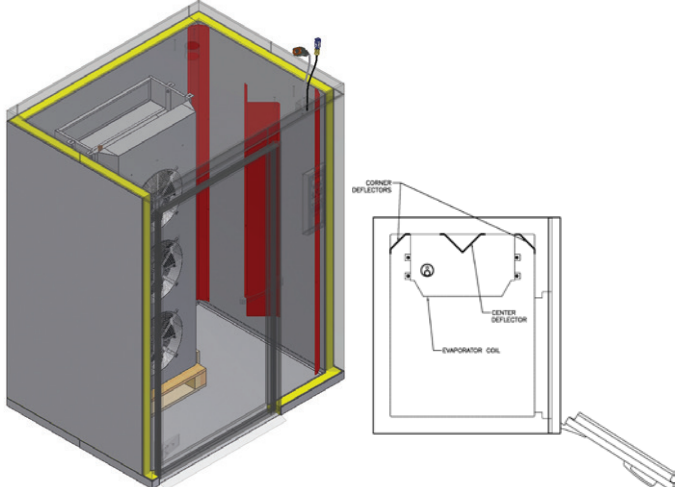
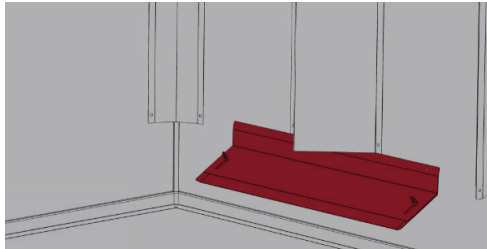
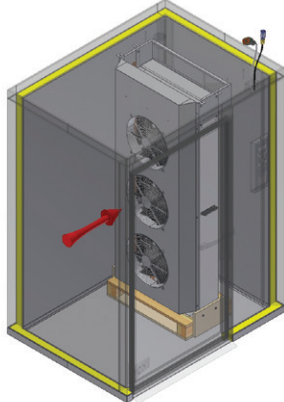
Step	Description	Diagram
5	<p>Place and fasten roof panel. Route control cables through roof panel cutout.</p>	
6	<p>Install the air deflectors (per the instructions below) on the wall where the evaporator assembly will be installed.</p> <ul style="list-style-type: none"> <li>Align the top of the corner air deflectors to the ceiling panel.</li> <li>Align the center air deflector at 9" below the ceiling panel.</li> <li>Be sure the center deflector is centered on the side wall</li> </ul>	
7	<p>Mount the condensate diverter immediately below the center air deflector. Make sure the diverter is leveled and centered on the wall.</p>	
8	<p>Position the coil assembly along the side wall behind the side of the door where the unit controller is located.</p>	

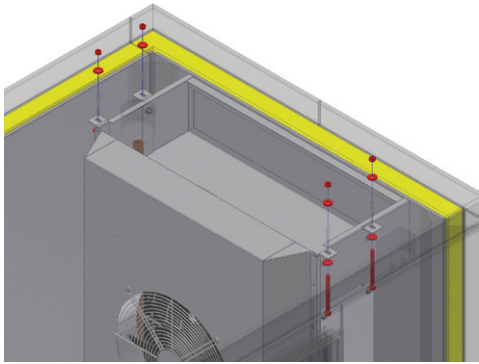
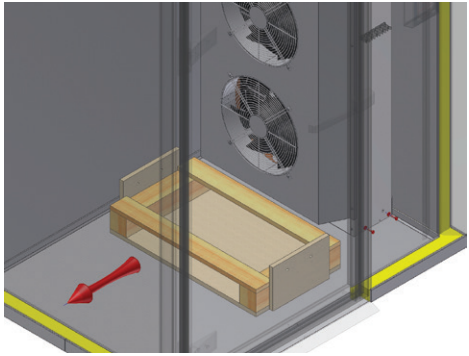
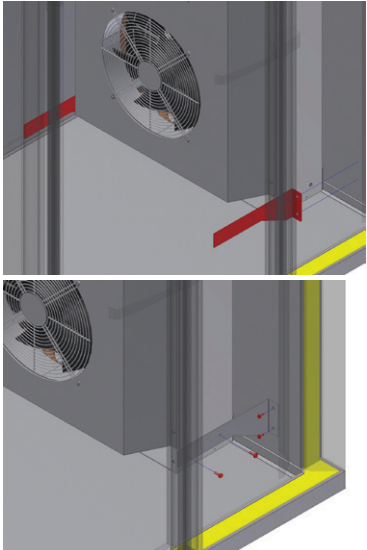
Step	Description	Diagram
<p><b>9</b></p>	<p>Secure the evaporator to the roof panel using the 3/8" screws, washers and nuts provided.</p> <p>Take your time and tighten each screw one turn at a time in a diagonal pattern to avoid damaging the screws.</p>	
<p><b>10</b></p>	<p>Remove and discard the temporary wooden support frame.</p>	
<p><b>11</b></p>	<p>Use the provided screws to install the lower evaporator brackets. The wall panel is not pre-drilled and will need to be tapped in the field.</p>	

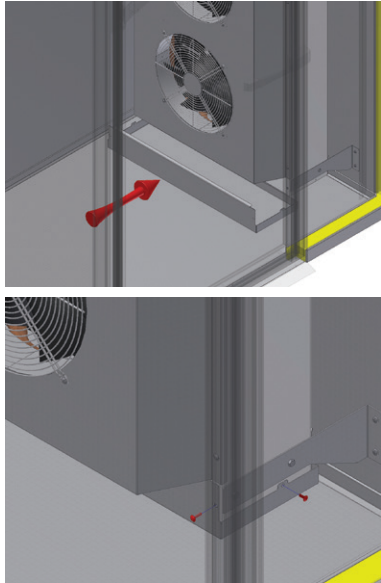
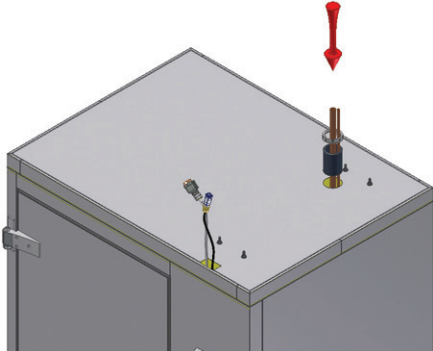
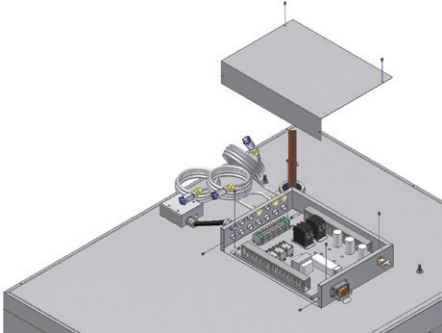
Step	Description	Diagram
<p><b>12</b></p>	<p>Use the provided screws to install the drain pan below the evaporator. Adjust the condensate diverter (mounted at step 7 above) so the water will dip inside the drain pan and after that tighten the wing nuts.</p> <p>Make sure the diverter does not touch the bottom of the drain pan. Route the drain line and connect the drain pan to it. When drilling the opening for the drain through the panel special precautions should be taken not to drill through a cam-lock.</p> <p>The edge of the lock extends 4.25" from the cam-lock access hole.</p>	
<p><b>13</b></p>	<p>Connect the refrigeration line sets. Evaporator assembly cover must be opened to access line connections.</p>	
<p><b>14</b></p>	<p>Mount the electric panel on top of the unit.</p>	

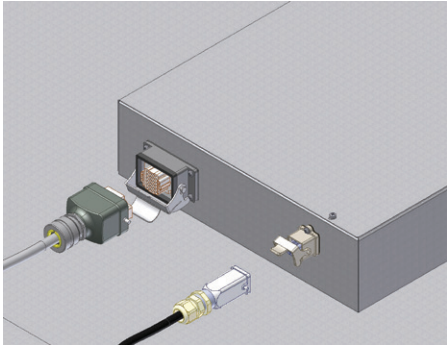
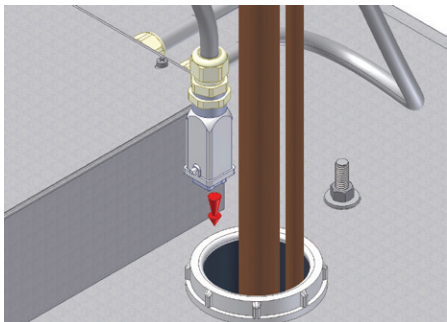
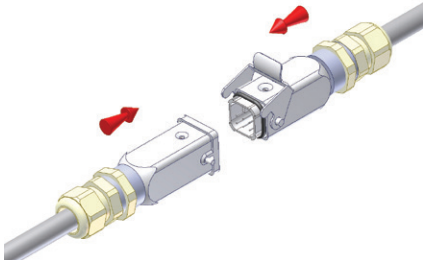
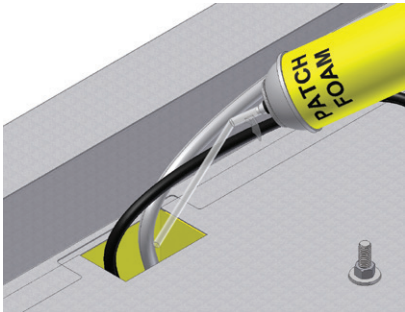
Step	Description	Diagram
15	Make the electrical connections to the electrical panel.	 <p>The diagram shows a grey electrical panel with a green terminal block on the left and a multi-pin connector on the right. A grey cable with a green connector is plugged into the terminal block. A black cable with a multi-pin connector is plugged into the panel's connector.</p>
16	Route the cables and connectors through the line set opening.	 <p>The diagram shows a vertical brown pipe passing through a hole in a grey cabinet. A grey cable with a multi-pin connector is being fed through the hole. A red arrow points downwards, indicating the direction of cable routing. A metal nut and washer are shown next to the hole.</p>
17	<p>Make the electrical connections inside the evaporator assembly.</p> <p>If the blast chiller is equipped with pass-thru door, install the provided J-boxes and make the connections for the door heater and the door switch. The pig-tail cables coming from the controller will be clearly marked.</p>	 <p>The diagram shows two metal J-boxes with red arrows pointing to their top covers. Two grey cables with multi-pin connectors are shown, one of which is being inserted into one of the J-boxes.</p>
18	Insulate all penetrations into the cabinet using the provided patch foam.	 <p>The diagram shows a grey cabinet with a hole. A grey cable is passing through the hole. A yellow foam patch is being applied around the cable to insulate the penetration. The foam patch has the word 'PATCH' and 'FOAM' printed on it. A metal nut and washer are shown next to the hole.</p>

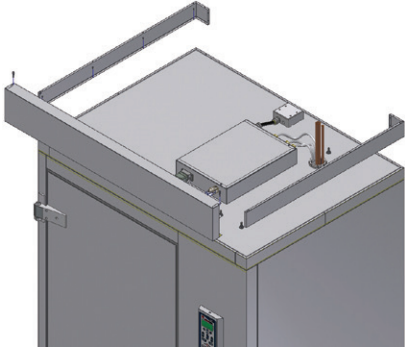
Step	Description	Diagram
19	Install and secure the provided stainless steel cowlings atop the unit.	 A 3D perspective diagram of a grey metal cabinet. The top surface is partially covered by a stainless steel cowl. A vertical rod is shown passing through the cowl and into the cabinet's interior. The diagram illustrates the correct placement and alignment of the cowl on the unit's top edge.
20	Make the main electrical connection at the 4x4 j-box marked "MAKE THE ELECTRICAL CONNECTIONS HERE".	

## Units with Multiple Evaporators - Installation

When installing a unit with multiple evaporators refer to the provided floor plans to assemble the cabinet and refer to Unit Assembly section of this manual to install the air deflectors and evaporator coils for each cabinet.



**Note:** Install the center and corner air deflectors prior to installing the evaporator coil see the layouts below.

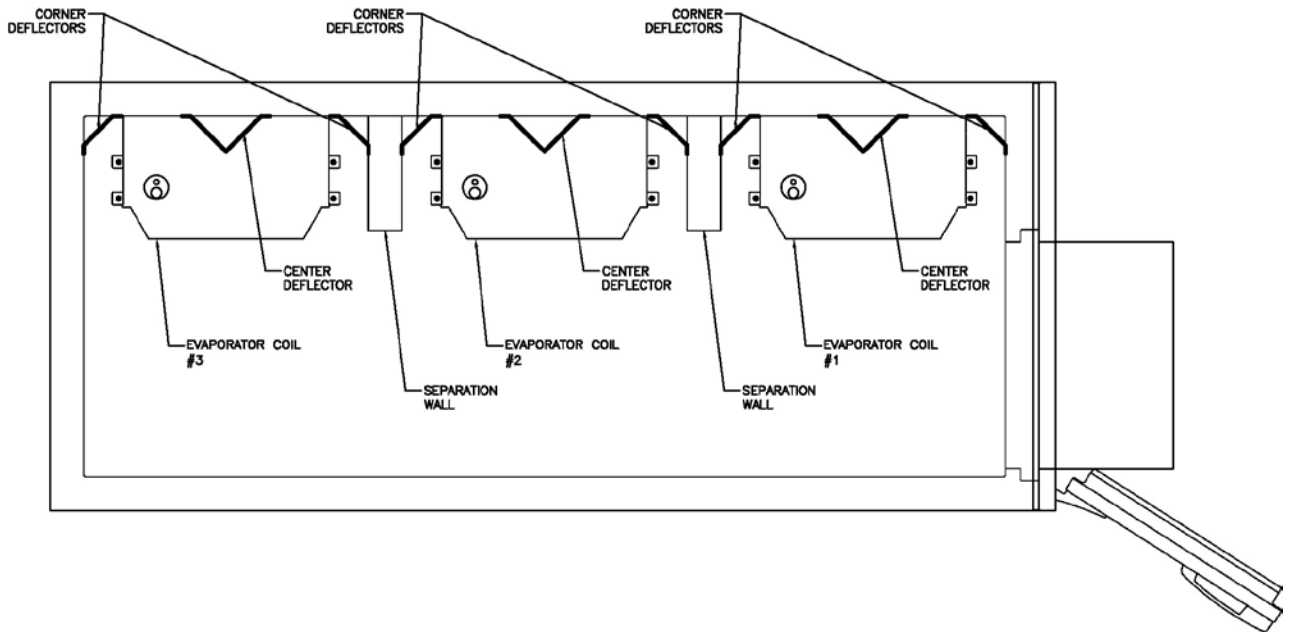
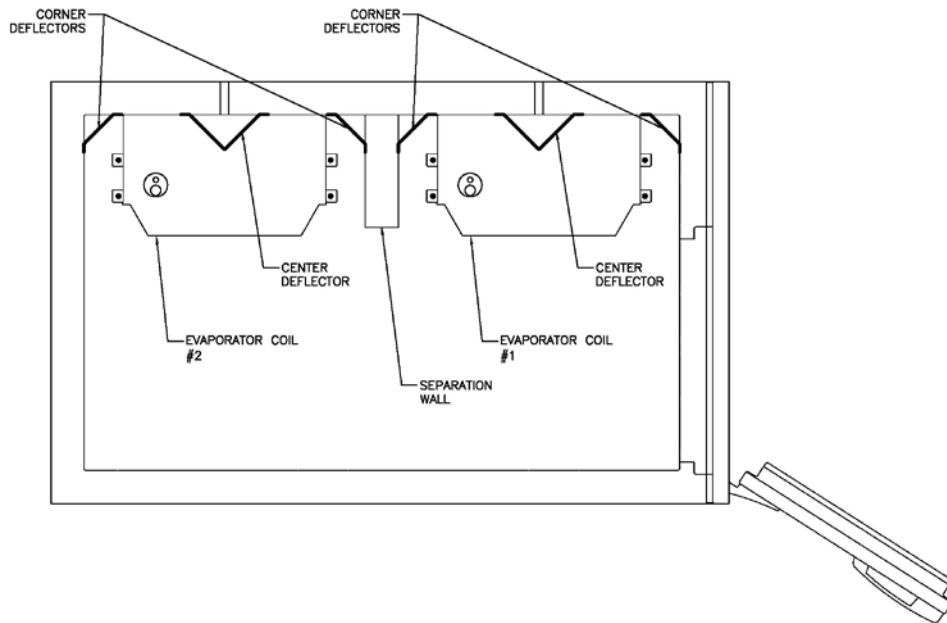

## Specifications and Performance

Blast chilling - Units can lower the temperature of food from 160°F to 38°F within 90 minutes.

Shock freeze - Units can lower the temperature of food from 160°F to 0°F within 300 minutes.



**Note: Overloading the unit could significantly reduce its service life.**

Model	Type	Mobile Rack Maximum Size (WxDxH)	Chilling Capacity (Lbs. /90 min)	Freezing Capacity (Lbs /300 Min)
AP20BC-1T	Blast Chiller	(1) 26" x 32" x 73.5"	200	N/A
AP20BC-2T	Blast Chiller	(2) 26" x 32" x 73.5"	400	N/A
AP20BC-3T	Blast Chiller	(3) 26" x 32" x 73.5"	600	N/A
AP26BC-1T	Blast Chiller	(1) 26" x 36" x 73.5"	260	N/A
AP26BC-2T	Blast Chiller	(2) 26" x 36" x 73.5"	520	N/A
AP26BC-3T	Blast Chiller	(3) 26" x 36" x 73.5"	780	N/A
AP36BC-1T	Blast Chiller	(1) 31" x 38" x 73.5"	360	N/A
AP36BC-2T	Blast Chiller	(2) 31" x 38" x 73.5"	720	N/A
AP36BC-3T	Blast Chiller	(3) 31" x 38" x 73.5"	1,080	N/A
AP46BC-1T	Blast Chiller	(1) 35" x 39" x 73.5"	460	N/A
AP46BC-2T	Blast Chiller	(2) 35" x 39" x 73.5"	920	N/A
AP46BC-3T	Blast Chiller	(3) 35" x 39" x 73.5"	1,380	N/A
AP20BCF-1T	Blast Chiller/Shock Freezer	(1) 26" x 32" x 73.5"	200	120
AP20BCF-2T	Blast Chiller/Shock Freezer	(2) 26" x 32" x 73.5"	400	240
AP20BCF-3T	Blast Chiller/Shock Freezer	(3) 26" x 32" x 73.5"	600	360
AP26BCF-1T	Blast Chiller/Shock Freezer	(1) 26" x 36" x 73.5"	260	156
AP26BCF-2T	Blast Chiller/Shock Freezer	(2) 26" x 36" x 73.5"	520	312
AP26BCF-3T	Blast Chiller/Shock Freezer	(3) 26" x 36" x 73.5"	780	468
AP36BCF-1T	Blast Chiller/Shock Freezer	(1) 31" x 38" x 73.5"	360	216
AP36BCF-2T	Blast Chiller/Shock Freezer	(2) 31" x 38" x 73.5"	720	432
AP36BCF-3T	Blast Chiller/Shock Freezer	(3) 31" x 38" x 73.5"	1,080	648
AP46BCF-1T	Blast Chiller/Shock Freezer	(1) 35" x 39" x 73.5"	460	276
AP46BCF-2T	Blast Chiller/Shock Freezer	(2) 35" x 39" x 73.5"	920	552
AP46BCF-3T	Blast Chiller/Shock Freezer	(3) 35" x 39" x 73.5"	1,380	828



**NOTE: Each unit was designed for a specific product capacity as shown above. Overloading the unit could significantly reduce the service life of the unit.**

## Check for Proper Installation

Perform the checks below to ensure optimal operating conditions and to maximize the service life of the equipment.

1. Check the integrity of the unit.
2. Check for proper location.
  - Ambient temperature no greater than 90°F (to ensure rated performance)
  - Must not be installed near heat source
  - Must not be installed near grease source
  - Must not be installed near vapor source
  - Must not be installed in direct sun light
  - Must not be installed in closed areas with insufficient air change
3. Check for proper clearances
  - 12" clearance for proper door operation if unit is adjacent to building wall (Models AP20/AP26)
  - 14" clearance for proper door operation if unit is adjacent to building wall (Models AP36)
  - 16" clearance for proper door operation if unit is adjacent to building wall (Models AP46)
  - 15" clearance above the unit for service
  - Provide enough space in front to allow door opening
  - Check for unobstructed air at the condensing unit
4. Check to ensure the unit is level.
5. Confirm the connected electrical service is in accordance with the manufacturer nameplate located on the unit.
6. Confirm that the installation of the refrigeration lines was done in accordance with the installation instructions in the previous chapter.
7. Check the installation of the drain pan and line and check for proper drainage.
8. Operate the unit in Hard Chill, Manual Mode for 20 minutes to verify temperature pull-down.



**NOTE: American Panel Corporation blast chillers are equipped with a short cycle protection. If the unit is stopped or the door is opened and closed during a chilling cycle more than once, the compressor will not start for 3 to 5 minutes.**

9. Engage, operate, and verify effectiveness of manual defrost cycle.
10. Verify ozone sanitation (if so equipped) is functional.
11. Verify PC connection (if so equipped) is functional.
12. Inform the factory if any functional or performance issues were found following the above tests.

## Modes Explained



Each unit is capable of running in either an ‘Automatic’, ‘Manual’ or ‘A la Carte’ mode:







- In ‘Automatic’ mode the unit will read the food temperature via the food probe and adjust the air temperature accordingly.







**NOTE: When using ‘Automatic’ mode it is very important to insert the food probe in the product. The food probe must read the core temperature of the product in order for the unit to work as intended.**

- In ‘Manual’ mode the air within the cabinet will be held at a preset temperature for a preset amount of time based on the selected operating cycle (see below).
- In ‘A la Carte’ mode the air within the cabinet will be held at a preset temperature until all of the timers expire.

Cycle	Description	Button (icon)
<b>Soft Chill</b>	Used for delicate items and salad items. Items with low fat or moisture content such as bakery goods should also use this mode.	
<b>Auto</b>	<b>Automatic Mode:</b> The air temperature will cycle between 28°F and 35°F until the food core temperature will reach 40°F, at this point the blast chiller will switch into holding mode where the air temperature will cycle between 35°F and 42°F until the food is removed from the cabinet and/or cycle is stopped by the operator.	
<b>Manual</b>	<b>Manual Mode:</b> The air temperature will cycle between 28°F and 35°F for 1.5 hours. After 1.5 hours the unit will switch into holding mode where the air temperature will cycle between 35°F and 42°F until the food is removed from the cabinet and/or cycle is stopped by the operator.	
<b>A La Carte</b>	<b>A La Carte:</b> The air temperature will cycle between 28°F and 35°F until all the timers expire, after that the unit will switch into holding mode where the air temperature will cycle between 35°F and 42°F until the cycle is manually stopped by the operator.	
<b>Hard Chill</b>	Used for all foods. Some freezing on the food surface may occur, especially with thicker products; if this is not acceptable use the ‘Soft’ cycle as described above.	
<b>Auto</b>	<b>Automatic Mode:</b> The air temperature will cycle between 0°F and 10°F until the food core temperature will reach 60°F (first part of the cycle). After the food core temperature reaches 60°F the air temperature inside the unit will cycle between 28°F and 35°F (second part of the cycle) until the food core temperature will reach 40°F. At this point the blast chiller will switch into holding mode where the air temperature will cycle between 35°F and 42°F until the food is removed from the cabinet and/or cycle is stopped by the operator.	
<b>Manual</b>	<b>Manual Mode:</b> The air temperature will cycle between 0°F and 10°F for one hour (first part of the cycle). After one hour the air temperature inside the unit will cycle between 28°F and 35°F for another hour (second part of the cycle). At this point the blast chiller will switch into holding mode where the air temperature will cycle between 35°F and 42°F until the food is removed from the cabinet and/or cycle is stopped by the operator.	
<b>A La Carte</b>	<b>A La Carte:</b> The air temperature will cycle between 0°F and 10°F until all the timers expire, after that the unit will switch into holding mode where the air temperature will cycle between 35°F and 42°F until the cycle is manually stopped by the operator.	

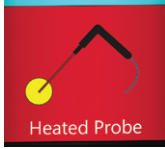
Cycle	Description	Button (icon)
<b>Shock Freeze</b>	Use for all freezing needs. When using the Shock Freezing Cycle the ice crystals that form within the product are very small. The quality and the texture of the product is preserved. For that reason, the Shock Freeze Cycle is suitable even for delicate products such as sushi meat and prime meat cuts. Shock Freeze Cycle will give excellent results when used in the process of Ice Cream and Gelato hardening, it will give a smooth texture to the product.	
	<b>Automatic Mode:</b> The air temperature will cycle between -20°F and -15°F until the food core temperature will reach 0°F, at this point the blast chiller will switch into holding mode where the air temperature will cycle between -4°F and 3°F until the food is removed from the cabinet and/or cycle is stopped by the operator.	
	<b>Manual Mode:</b> The air temperature will cycle between -20°F and -15°F for 4 hours. After 4 hours the unit will switch into holding mode where the air temperature will cycle between -4°F and 3°F until the food is removed from the cabinet and/or cycle is stopped by the operator.	
	<b>A La Carte:</b> The air temperature will cycle between -20°F and -15°F until all the timers expire, after that the unit will switch into holding mode where the air temperature will cycle between -4°F and 3°F until the cycle is manually stopped by the operator.	
	<b>NOTE:</b> <i>At the end of any cycle the unit will switch into holding mode to maintain the food at a specific temperature. However, the unit is not designed to be a refrigerator or holding cabinet. Do not allow the blast chiller to function in holding mode for extended periods of time.</i>	
Occasional overnight holding is allowed.		
<b>Quick Start</b>	The Quick Start mode allows for one button operation of the most common cycle as defined by the user. Quick Start is set from the factory as a Soft Chill - Manual mode but can be customized in the settings for any cycle operation.	

Cycle	Description	Button (icon)
<b>Defrost</b>	Use this mode to defrost the evaporator coil. The defrost cycle must be manually engaged (see controller operation below). Defrost the unit once a day or as needed. Ice build-up can be observed by looking thru the fan grill at the evaporator coil. The factory preset for the Defrost Cycle is 30 minutes.	
<b>Thaw Cycle (if equipped)</b>	Use to thaw frozen products. Units equipped with the Thaw feature will be delivered with a special thaw probe, a cordless drill and a sanitary drill bit. Use the cordless drill and sanitary drill bit to provide a hole to probe the frozen product.	
	<b>Automatic Mode:</b> The air temperature will cycle between 42°F and 50°F until the food temperature, as recorded by the thaw probe, will reach 32°F; at this point the blast chiller will switch into holding mode where the air temperature will cycle between 35°F and 42°F until the food is removed from the cabinet and/or cycle is stopped by the operator.	
	<b>Manual Mode:</b> The air temperature will cycle between 42°F and 50°F for a preset amount of time, set by the operator at the time of starting the cycle. After the cycle time expires, the unit will switch into holding mode where the air temperature will cycle between 35°F and 42°F until the food is removed from the cabinet and/or cycle is stopped by the operator.	
	<b>NOTE: When probing for thaw cycle, use the drill bit to provide a hole in the frozen product.</b>	
<b>Heated Probe (if equipped)</b>	Use the Heated Probe feature prior to extracting the temperature probe from the frozen product. Gentle heat will be applied to the food probe for 5 seconds to facilitate the extraction of the probe. The Heated Probe will run only if the temperature at the food probe is below 30°F. Repeat the heated probe cycle if needed.	
<b>Sanitize (if equipped)</b>		

Factory Presets Automatic Mode - Quick Reference Chart								
Cycle \ Setting	Low Air Part 1	High Air Part 1	Breaking Temp.	Low Air Part 2	High Air Part 2	End Food Temp.	Low Air Holding	High Air Holding
Soft	28°F	35°F	NA	NA	NA	40°F	35°F	42°F
Hard (Chillers Only)	10°F	20°F	60°F	28°F	35°F	40°F	35°F	42°F
Hard (Chillers & Freezers)	0°F	10°F	60°F	28°F	35°F	40°F	35°F	42°F
Shock Freeze	-20°F	15°F	NA	NA	NA	0°F	-4°F	3°F
Thaw	42°F	50°F	NA	NA	NA	32°F	35°F	42°F

Factory Presets Manual Mode - Quick Reference Chart								
Cycle \ Setting	Low Air Part 1	High Air Part 1	Time Part 1	Low Air Part 2	High Air Part 2	Time Part 2	Low Air Holding	High Air Holding
Soft	28°F	35°F	NA	NA	NA	90 Min	35°F	42°F
Hard (Chillers Only)	10°F	20°F	60 Min	28°F	35°F	60 Min	35°F	42°F
Hard (Chillers & Freezers)	0°F	10°F	60 Min	28°F	35°F	60 Min	35°F	42°F
Shock Freeze	-20°F	15°F	NA	NA	NA	300 Min	-4°F	3°F
Thaw	42°F	50°F	NA	NA	NA	Set at Start	35°F	42°F



## Home Screen

The home screen can be accessed by tapping on the blank display, if the display is off, or by pressing the home button, if the controller is in one of the cycle screens.



- 1) **Soft Chill Button** – Press to access Soft Chill Cycle Menu
- 2) **Hard Chill Button** – Press to access Hard Chill Cycle Menu
- 3) **Shock Freeze Button** – Press to access Shock Freeze Cycle Menu
- 4) **Quick Start Button** – Press to engage the preset cycle, the Quick Start Button is set from the factory to engage the Soft Chill cycle in Manual Mode. The operator can set the Quick Start Button to engage the desired cycle, see **Settings -> Quick Start**.
- 5) **Food Thaw Button** – Press to access Food Thaw Cycle Menu. Food Thaw Cycle is an optional cycle and is available on selected models only.
- 6) **Sanitize Button** – Press to access the Sanitize Cycle Menu. Sanitize Cycle is optional and is available on selected models only. Sanitize Cycle will sanitize the interior of the cabinet. Sanitize Cycle can be set to engage automatically at preset times of the day when unit not in use, see **Settings -> Sanitize**.
- 7) **Defrost Cycle Button** – Press to access the Defrost Cycle Menu. Defrost Cycle can be set to engage automatically at preset times of the day when unit not in use, see **Settings -> Defrost**.
- 8) **Reports Button** – Press to access the HACCP reports preview menu.
- 9) **Probe Heat Button** – Press to choose which food probe to heat for easier extraction from the frozen product.
- 10) **Settings Button** – Press to access the settings menu.

## Automatic Mode Screen

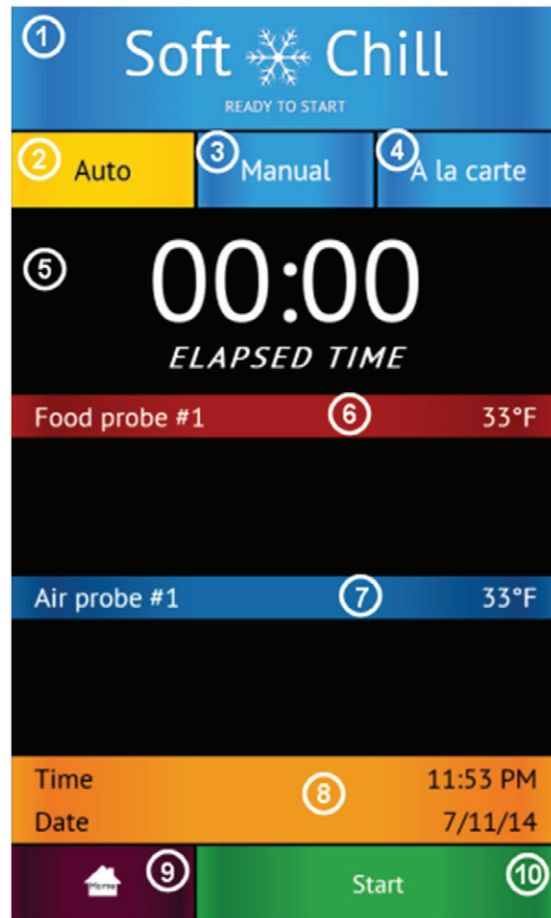

- 1) **Status Label** – Displays the selected cycle and the status of the cycle.

**Status:**





**READY TO START** – unit in standby mode waiting for the user to make a selection such as Start

**CYCLE IN PROGRESS** – the chilling cycle is in progress

**COMPLETED** – the chilling cycle has been completed and the unit is maintaining the product at safe holding temperatures

- 2) **Auto Mode Button** – Press to select the automatic blast chilling mode.
- 3) **Manual Mode Button** – Press to switch to the manual blast chilling mode.
- 4) **A la carte Mode Button** – Press to switch to the A la carte blast chilling mode.
- 5) **ELAPSED TIME Label** – Displays the elapsed time form the start of the cycle.
- 6) **Food probe #... Label/Button** – Press to assign to the current probe the food ID that it monitors. The assigned food ID will show on the HACCP reports. The label of Food probe #... will display the temperature of the probe. One food probe is the standard configuration for all American Panel Corporation blast chillers, the controller supports up to 4 food probes.
- 7) **Air probe #... Label** – Displays the air temperature inside the cabinet. Double and triple depth cabinet models will have two and three air probes respectively, one for each cabinet.
- 8) **Time and Date Label** – Displays the current date and time.
- 9) **Home Button** – Press to stop the current cycle and switch to the home screen.
- 10) **Start/Stop Button** – Press to start or stop the cycle. If the stop button will be pressed during the cycle a confirmation screen will prompt the user to confirm the choice.

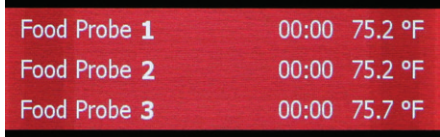
## How to Start a Cycle in Automatic Mode

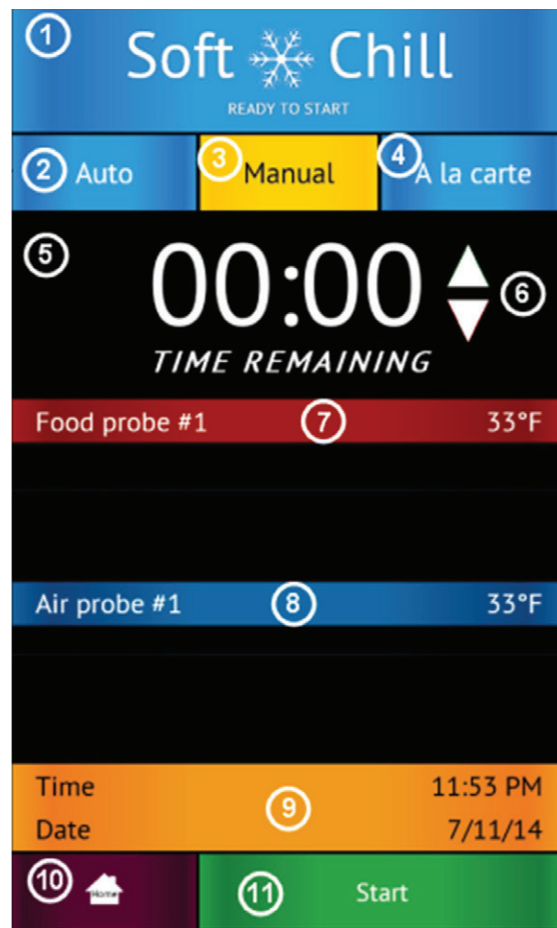

Step	Description	Action									
1	Choose Soft Chill, Hard Chill or Shock Freeze from the Home screen										
2	Make sure Auto tab is selected <i>(For the Auto mode to work as intended the food probe must be inserted into the product)</i>										
3	<b>Optional:</b> press Food Probe # to assign a Food ID to the Probe. Choose from a set list of Food IDs or enter your own name.	 <table border="1" data-bbox="1024 903 1461 1039"> <tr> <td>Food Probe 1</td> <td>00:00</td> <td>75.2 °F</td> </tr> <tr> <td>Food Probe 2</td> <td>00:00</td> <td>75.2 °F</td> </tr> <tr> <td>Food Probe 3</td> <td>00:00</td> <td>75.7 °F</td> </tr> </table>	Food Probe 1	00:00	75.2 °F	Food Probe 2	00:00	75.2 °F	Food Probe 3	00:00	75.7 °F
Food Probe 1	00:00	75.2 °F									
Food Probe 2	00:00	75.2 °F									
Food Probe 3	00:00	75.7 °F									
4	Press start to start the cycle										

## Manual Mode Screen

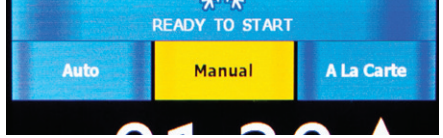
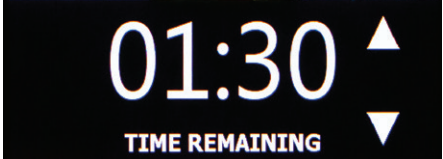

- 1) **Status Label** – Displays the selected cycle and the status of the cycle  
**Status:**  
**READY TO START** – unit in standby mode waiting for the user to make a selection such as Start  
**CYCLE IN PROGRESS** – the chilling cycle is in progress  
**COMPLETED** – the chilling cycle has been completed and the unit is maintaining the product at safe holding temperatures
- 2) **Auto Mode Button** – Press to select the automatic blast chilling mode.
- 3) **Manual Mode Button** – Press to switch to the manual blast chilling mode.
- 4) **A la carte Mode Button** – Press to switch to the A la carte blast chilling mode.
- 5) **TIME REMAINING Label** – Indicates the remaining time to the end of the cycle.
- 6) **UP/DOWN BUTTONS** – Press to adjust the cycle time as needed.
- 7) **Food probe #... Label/Button** – Press to assign to the current probe the food ID that it monitors. The assigned food ID will show on the HACCP reports. The label of Food probe #... will display the temperature of the probe. One food probe is the standard configuration for all American Panel Corporation blast chillers, the controller supports up to 4 food probes.
- 8) **Air probe #... Label** – Displays the air temperature inside the cabinet. Double or triple depth cabinet models will have two or three air probes respectively, one for each cabinet.
- 9) **Time and Date Label** – Displays the current date and time.
- 10) **Home Button** – Press to stop the current cycle and switch to the home screen.
- 11) **Start/Stop Button** – Press to start or stop the cycle. If the stop button will be pressed during the cycle a confirmation screen will prompt the user to confirm the choice.

## How to Start a Cycle in Manual Mode

Step	Description	Action
1	Choose Soft Chill, Hard Chill or Shock Freeze from the Home screen	
2	Make sure Manual tab is selected	
3	<b>Optional:</b> Press up or down on the time arrows to adjust the cycle time	
4	<b>Optional:</b> press Food Probe # to assign a Food ID to the Probe. Choose from a set list of Food IDs or enter your own name.	
5	Press start to start the cycle	

## A La Cart Mode Screen & Timer Screen

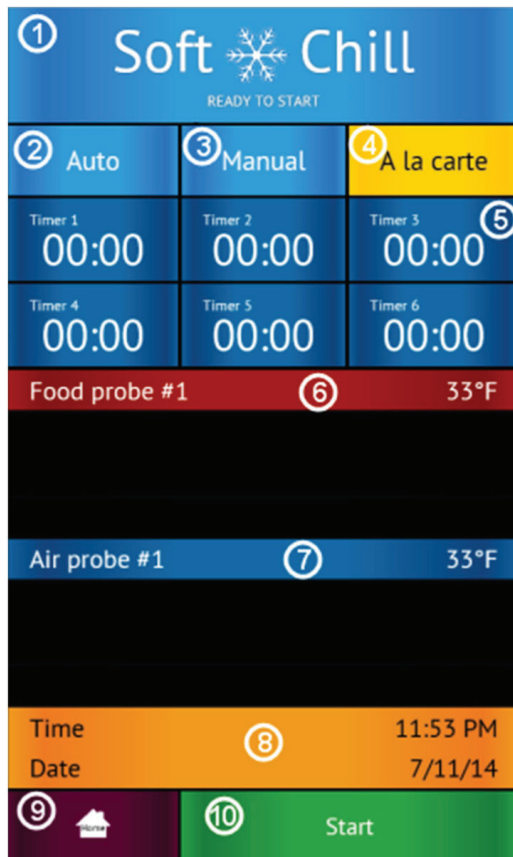

- 1) **Status Label** – Displays the selected cycle and the status of the cycle

**Status:**





**READY TO START** – unit in standby mode waiting for the user to make a selection such as Start

**CYCLE IN PROGRESS** – the chilling cycle is in progress

**COMPLETED** – the chilling cycle has been completed and the unit is maintaining the product at safe holding temperatures

- 2) **Auto Mode Button** – Press to select the automatic blast chilling mode.
- 3) **Manual Mode Button** – Press to switch to the manual blast chilling mode.
- 4) **A la carte Mode Button** – Press to switch to the A la carte blast chilling mode.
- 5) **Timer Buttons/Labels** – Press to access the timer setting screen. The timer label will indicate the remaining time and the product name of the food it monitors.
- 6) **Food probe #... Label** - The label of Food probe #... will display the temperature of the probe. One food probe is the standard configuration for all American Panel blast chillers, the controller supports up to 4 food probes.
- 7) **Air probe #... Label** – Displays the air temperature inside the cabinet. Double or triple depth cabinet models will have two or three air probes respectively, one for each cabinet.
- 8) **Time and Date Label** – Displays the current date and time.
- 9) **Home Button** – Press to stop the current cycle and switch to the home screen.
- 10) **Start/Stop Button** – Press to start or stop the cycle. If the stop button will be pressed during the cycle a confirmation screen will prompt the user to confirm the choice.
- 11) **Set Timer Id Button** – Press to assign a food id. to the current timer.
- 12) **Up/Down Buttons** – Press to adjust the timer.

## How to Start a Cycle in A La Cart Mode

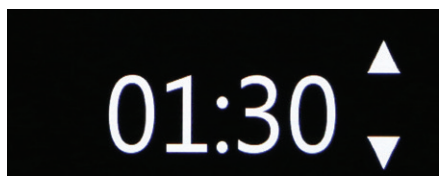
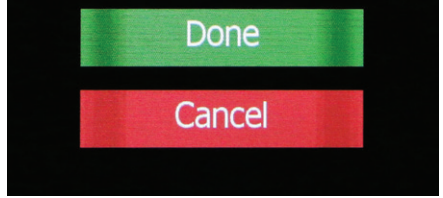
Step	Description	Action
1	Choose Soft Chill, Hard Chill or Shock Freeze from the Home screen	
2	Make sure A la carte tab is selected	
3	Select any available timer. Available timers are the ones set at 00:00 and have not yet been activated.	
4	<b>Optional:</b> Press Food ID to assign a Food ID to the timer. Choose from a preset list of IDs or enter your own.	
5	Press up or down on the time arrows to adjust the cycle time	
6	Press Done to start the cycle	
	Up to 6 timers can be added in the A la carte mode.	

## How to Start a Cycle in Quick Start Mode & Customizing Quick Start

The Quick Start mode allows for one button operation of the most common cycle as defined by the user. Quick Start is set from the factory as a Soft Chill - Manual mode but can be customized in the settings for any cycle operation.

Press the Quick Start button to engage the preset cycle

To customize the Quick Start button, follow the steps below.



Step	Description	Action
1	To customize the cycle and mode that the Quick Start button engages, select Settings from the home screen and then Quick Start.	
2	Select the Cycle (Soft Chill, Hard Chill or Shock Freeze)	
3	Select the Mode (A la cart, manual or automatic)	
4	Enter a product name (Optional) from a list of items, or enter your own on the screen.	
5	Select Done to save your settings.	

## PC Connection Package

The optional wireless pc communication package features:

- HACCP data download via local Wi-Fi network or peer-to-peer connection
- Remote blast chiller monitoring via Wi-Fi network
- E-mail notifications

### Connect to Controller - Direct Connection



*The optional wireless pc communication package is required to connect to the controller.*

The controller is set from the factory as a Wi-Fi access point. In this configuration the controller broadcasts an SSID such as blast-chiller-xxxxxxxxx-wha.

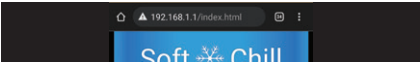
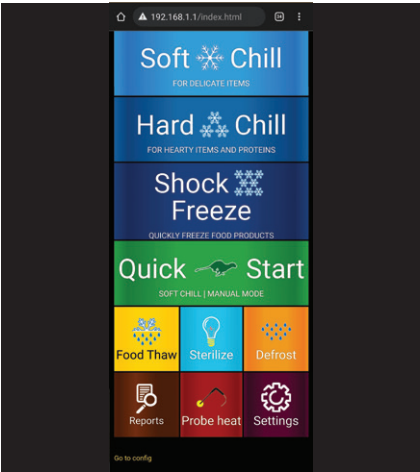
Step	Description	Action
1	Open the Wi-Fi connections on the device you want to use to access the controller	
2	Connect to the SSID of the unit - blast-chiller-xxxxxxxxx-wha is the SSID that is set from the factory. If this has been previously customized, use the current SSID in the system.	
3	Open a web browser on the device and enter 192.168.1.1 into the address bar.	
4	The home screen of the controller should show up in the browser window. You are now able to download HACCP data, monitor the blast chiller modes and set up any notification settings.	

## Connect to Controller - Wi-Fi



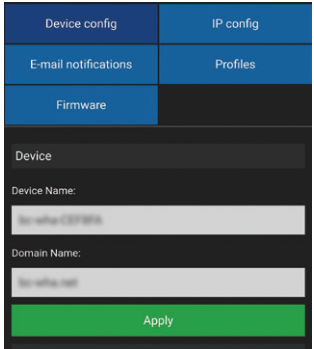
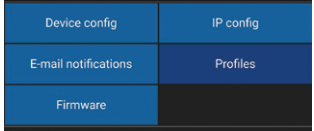
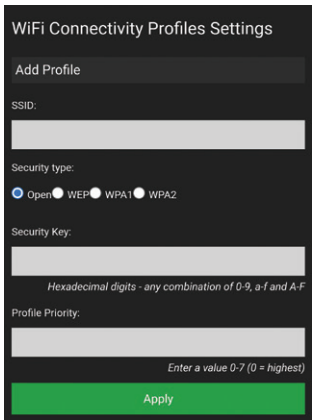

**The optional wireless pc communication package is required to connect to the controller.**

The controller is set from the factory as a Wi-Fi access point. In this configuration the controller broadcasts an SSID such as blast-chiller-xxxxxxxxxx-wha.

Step	Description	Action
1	Connect to the controller through the Direct Connection steps outlined on pg 28. Once connected on a browser, complete the steps below	
2	Press the “Go to config” button at the bottom of the screen.	
3	Make sure the “Device config” tab is selected Enter the desired name for your HURRiCHiLL device.	
4	Select the “Profiles” tab	
5	Enter the SSID for your wi-fi network Choose the correct security type for your network Enter your network security key (password) Enter 0 in Profile Priority Click the “Apply” button to save all the changes Click the “Go to application” button to go back to the main screen.	
6	Reset power to the unit and allow few minutes for the controller to connect to the Wi-Fi network.	

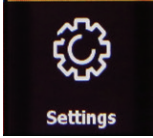
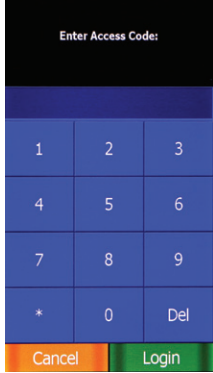
**Connect to Controller - Wi-Fi *continued***

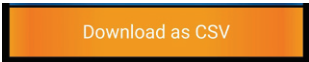
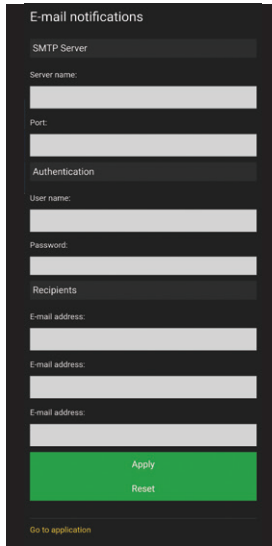
Step	Description	Action
7	Once the unit has restarted, Check the wi-fi settings by selecting the Settings button on the home screen of the unit.	
8	Enter the controller password and hit done	
9	Press the PC button to access the wi-fi settings	
10	Press the Wi-Fi Configuration button	
11	<p>A list of settings will be shown including Name, SSID it is connected to and IP Address.</p> <p>Your unit is now set up for wireless access.</p>	

### Connect to Controller - Wi-Fi notifications setup

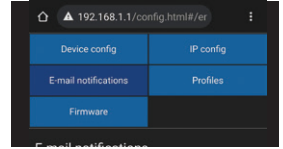
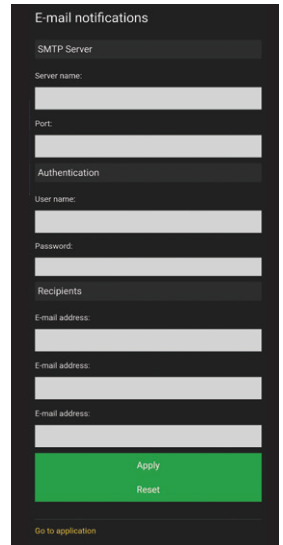
Step	Description	Action
1	Connect to the controller through the Direct Connection steps outlined on pg 28. Once connected on a browser, complete the steps below	
2	Press the “Go to config” button at the bottom of the screen.	
3	Make sure the “Email Notifications” tab is selected	
4	Enter the info for the fields below: <ul style="list-style-type: none"> <li>• STP server name</li> <li>• Port type</li> <li>• Email address notifications will come FROM</li> <li>• Email account password</li> <li>• Email recipient - you can add up to 3 emails to send TO</li> <li>• Click “Apply” when done</li> <li>• Click “Go to Application” to exit</li> </ul>	

### HACCP Data Download via USB

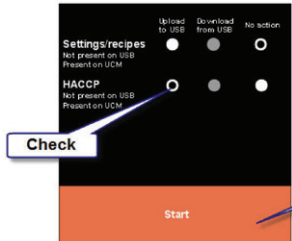

*The optional USB pc communication package is required to connect to the controller.*

Step	Description	Action
1	Insert a usb drive into the controller port shown.	
2	Check the settings on screen for the data needed.	
3	Press “Start” to download the file.	

## HACCP Data Download via Peer to Peer

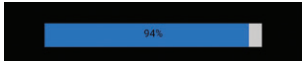
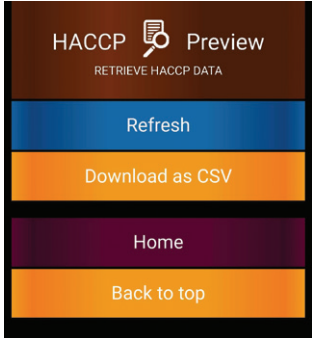

*The optional wireless pc communication package is required to connect to the controller.*

Step	Description	Action
1	Connect to the controller through the Direct Connection steps outlined on pg 28. Once connected on a browser, complete the steps below	
2	Press the “Reports” button on the home screen in your browser.	
3	Click Refresh to load the most current data. Wait until the refresh is complete - the bar will hit 100% and you will see the updated data on screen.	
4	Click the Download button to download the HACCP data as a CSV file to your device.	

## HACCP Data Download via Wi-Fi



*The optional wireless pc communication package is required to connect to the controller.*

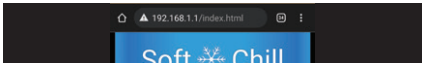
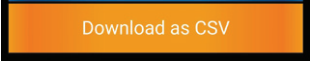



Step	Description	Action
1	Make sure the blast chiller is connected to a local wi-fi network as outlined on section “ Connect to Controller - Wi-Fi” Make note of the IP address of the machine. Connect the device to the same wi-fi network as the blast chiller.	
2	Enter the blast chiller IP address from step 1 into a browser on your device. This will connect to the unit over wi-fi and show the blast chiller home screen.	
3	Follow the steps in “HACCP Data Download via Peer to Peer” to download the data to your device.	

## Customizing the Cycles and Technical Settings

Blast chilling and shock freezing cycles have been designed to deliver optimum chilling/freezing performance for most food products. If needed, all the cycles and settings can be customized via the settings menu and the screens below. Settings should only be changed by knowledgeable personnel or at the direction from a service technician.

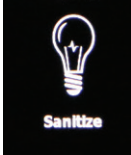
Setting	Description	Icon
<b>Soft Chill</b>	Temperature and timers settings for the Soft Chill cycle for each mode: Auto, Manual & A La Carte	
<b>Hard Chill</b>	Temperature and timers settings for the Hard Chill cycle for each mode: Auto, Manual & A La Carte	
<b>Shock Freeze</b>	Temperature and timers settings for the Shock Freeze cycle for each mode: Auto, Manual & A La Carte	
<b>Quick Start</b>	Customize the cycle, mode and product name used in the Quick Start button	
<b>Defrost</b>	Settings for: Length of Defrost, Auto Defrost, Auto Defrost Time, Cabinet Max Temp, Length of Auto Defrost	
<b>Date, Time, Language</b>	Sets the time, date and language (English, French or Spanish) of the unit.	
<b>Thaw</b>	Setts the Air Temp, Food Temp, Fan Settings and Duration for the Auto and Manual Food Thaw cycles.	
<b>Reports</b>	HACCP reports settings: Date Interval, Notification Threshold, Capacity Disply, Capacity Alert, Clear Reports.	

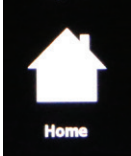
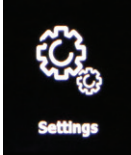
## Customizing the Cycles and Technical Settings - *Continued*

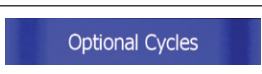
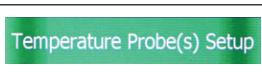
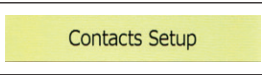
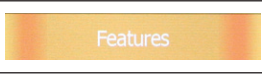
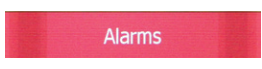
Setting	Description	Icon
<b>Sanitize</b>	Settings for: Length of Cycle, Auto Sanitation and Auto Sanitation Time.	
<b>PC</b>	Select the type of PC connection you use and see detailed info on the network settings.	
<b>Home</b>	Takes you back to the home screen	
<b>Settings</b>	Takes you to Technical Settings Screen - Optional Cycles, Temperature Probe(s) Setup, Contacts Setup, Features, Alarms, Brightness and Sound settings	 
	Optional Cycles - Choose additional non standard cycles	
	Probe Settings - Adjust probe temperatures and offsets	
	Contacts Settings - Settings for contact sensors in the unit.	
	Features - Technical features to be used by technician	
	Alarm Settings - Settings for all alarms	

## Temperature Probe Calibration

1. Determine the temperature offset for the probe you are calibrating. To do so, insert the food probe in an 80% ice 20% water bath and stir for a minute. Record the temperature of the probe as displayed on the touchscreen. The difference between 32 and the temperature reading is the temperature offset.
2. For example, temperature probe reading is 38°F. The temperature offset is -6 (32-38 = -6)
3. Calibrate the probe. To do so go to Settings (7055 Login) > Settings > Temperature Probes Setup. Set the offset calculated above for the desired temperature probe. Press Done button to go to the home screen.

## General Operating Instructions

---

### Panning and Loading

Follow the methods below for faster cooling, freezing and thawing:

- Place the food in shallow pans.
- Do not use food pans deeper than 2 ½" and do not fill the pan with more than 2" of product.
- Separate the food in smaller or thinner portions.
- Do not cover the containers unless danger of overhead contamination.
- Loosely cover the containers if necessary. Allow the cover material (aluminum foil) to touch the surface of the food.
- Arrange the pans for optimum air circulation within the cabinet.
- Know the capacity of the unit. Do not overload the unit.

### Probing (for chilling and freezing cycles)

Follow the methods below to ensure correct probing of the product:

- Insert the food probe into the thickest part of the product.
- The tip of the food probe will have to be located at the core of the food.
- Always place the available food probe in the hardest to cool product.
- It is a good practice to restart the cycle every time food is added.
- Clean and sanitize the food probe after each use.

### Probing (for optional Thaw cycle)

- Use the provided drill and drill bit to drill a hole into the frozen product.

## Maintenance & Cleaning

---

### Daily Maintenance

- Defrost the unit daily or as needed (pg 21).
- Wipe clean the interior and the exterior of the unit using a solution of mild soap and water.
- Wipe clean the door gasket.
- Engage the sanitation cycle (if equipped).

### Quarterly Maintenance

The quarterly maintenance should be done by a service technician or by trained maintenance personnel.

- Inspect door hinge for proper operation.
- Inspect door gasket for proper seal.
- Inspect the drain line for proper flow.
- Use vacuum and brush to clean the condenser coil.
- Clean the evaporator coil.

### Evaporator Coil Cleaning - see pg. 41

## Maintenance & Cleaning

---

**Annual Maintenance Checklist** The quarterly maintenance should be done by a service technician or by trained maintenance personnel.

- Verify unit is properly installed, firmly situated and level.
- Verify the electrical service to be in accordance with the manufacturer label located on evaporator coil assembly.
- Verify proper drain pan installation (clean if necessary) or hard plumbed. Inspect drain lines for integrity and proper flow.
- Check door hinges and gasket for proper operation and seal. Use mild soapy warm water to clean the door gasket.
- Inspect integrity of chilling compartment interior.
- Verify evaporator fans are firmly mounted, balanced, free-turning and properly aligned.
- Disconnect unit from the main power and clean the evaporator coil, see the evaporator coil cleaning procedure at the end of this checklist.
- Wipe down cabinet interior with soapy water and rinse. Do not use any abrasive or corrosive materials!
- Connect the unit to power supply.
- Use an 80/20 ice/water bath to check the accuracy of the probe. To do so, close the door of the unit with the probe hanging on the outside of the cabinet and start a manual hard cycle. Use the probe to continually stir the ice-water bath and observe the readings for approximately 3 minutes. The temperature of the ice-water mixture should be 33 to 34°F. Adjust as necessary, see Temperature Probe Calibration pg. 37.
- Verify the accuracy of the air probe against a calibrated thermocouple or against an accurate food probe. Adjust as necessary, see Temperature Probe Calibration pg. 37.



**Note:** *American Panel Corporation blast chillers are equipped with a short cycle protection. If the unit is stopped during a chilling cycle more than once, the compressor will not start for the following 3 minutes.*

- Operate the unit in the hard chill / manual mode, for approximately 20 minutes, to verify temperature pull down.
- Verify the functionality of the evaporator fans.
- Verify proper air flow direction. The direction of the air flow for the evaporator should be from the front of the unit towards the back of the unit.
- Engage, operate, and verify effectiveness of manual defrost cycle.
- Verify UV light (if so equipped) is functional. The UV lamps must be replaced annually, call the parts department at American Panel Corporation to order new lamps.

## Maintenance & Cleaning

---

### Annual Maintenance Checklist - *continued*

- Verify ozone generator (if so equipped) is functional. 10 minutes after engaging the sanitation cycle there will be a strong ozone smell inside the cabinet indicating that the ozone generator is functional. The UV lamp inside the ozone generator must be replaced annually – see chapter “Replace Ozone Generator Lamp”, call the parts department at American Panel Corporation to order new lamps.
- Verify Wi-Fi connection (if so equipped) is functional.
- Turn unit off, wipe down exterior.
- On the remote condensing unit perform the maintenance procedure recommended by its manufacturer.
- Inform the customer and the factory if any functional and performance issues were found following the completion of the above tests.
- Complete inspection paperwork and verify consumer has all necessary operation manuals, menus, and instructions. Contact factory with any questions, Monday-Friday 8:00 a.m. to 5:00 p.m. ET at 800-327-3015 or consult the website at [www.AmericanPanel.com](http://www.AmericanPanel.com)



***The above maintenance procedure should be done yearly and is not a substitute for an efficient local maintenance schedule such as daily, and quarterly maintenance schedule.***

## Evaporator Coil Cleaning

---

The following cleaning procedure is recommended as part of routine maintenance activity for all American Panel Corporation blast chillers.



**IMPORTANT: Do not use any sharp or abrasive tools to clean the evaporator coil!**

Before cleaning the evaporator coil run the defrost cycle to make sure the coil is completely free of ice.

When cleaning the evaporator coil particular attention must be paid to the kind of cleansing agent used. The following products **MUST NEVER BE USED**:

- Ammonia or detergents which contain ammonia (ammoniac solutions)
- Bleach or products containing bleach (chlorinated liquids)
- Acid detergents such as anti-lime scale, various anti-incrustations, muriatic acid, sulfuric, hydrochloric and acetic acid liquids, etc. (highly acidic liquids)
- Acetone, trichloro-ethylene (organic solvents)
- Caustic soda and other highly alkaline substances (high basicity liquids)

All the above substances can damage the protective coating and/or corrode the metal components and seriously damage the coil.



**WARNING: Disconnect and lock the main power switch prior to cleaning the unit.**

### Monthly

- Open the evaporator door by removing the screws that secure the door to the vertical frame and swing the door open.
- Use a vacuum cleaner or a soft non-metallic bristle to remove the surface loaded fibers and dirt. Apply the tool in the direction of the fins.
- Rinse the coil finned area and the return bends with plenty of clean warm water. To avoid damaging the fins and the coating, it is important that the water temperature is below 130oF and the water pressure is below 100 PSI.
- Close and secure the evaporator door.

### Quarterly

- Open the evaporator door by removing the screws that secure the door to the vertical frame and swing the door open.
- Use a vacuum cleaner or a soft non-metallic bristle brush to remove the surface loaded fibers and dirt. Apply the tool in the direction of the fins.
- Spray the coil finned area and the return bends with a generous amount of the recommended coil cleaner (see below) using a pump-up sprayer or conventional spray bottle. Refer to the manufacturer's directions on the container for proper mixing ratio.
- After cleaning the coil use the approved chloride remover (see below) to remove soluble salts and revitalize the unit. Use a pump-up sprayer or a conventional spray bottle to soak the finned area and the return bends. Refer to the manufacturer's directions on the container.
- Rinse the coil finned area and the return bends with plenty of clean warm water. To avoid damaging the fins and the coating, it is important that the water temperature is below 130oF and the water pressure is below 100 PSI.
- Close and secure the evaporator door.

#### Recommended Coil Cleaner



Enviro-Coil Concentrate  
Hydro-Balance Corporation  
Tel. (972) 394-9422

#### Recommended Chloride Remover

CHLOR\*RID DTS  
CHLOR\*RID International, Inc.  
Tel. (800) 422-3217

## Replace Optional Sanitizing Ozone Generator Lamp

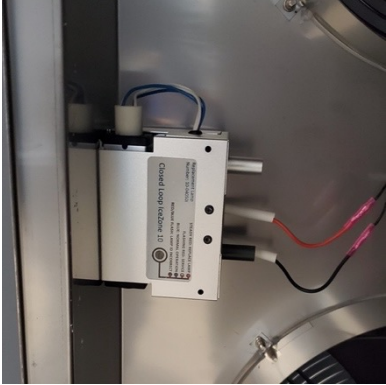
The UV lamp inside the ozone generator has a service life of one year. Contact the parts department at American Panel Corporation to order replacement lamps. To replace the lamp follow the steps below.

Step	Description	Action
1	Disconnect the unit from the main electrical power	
2	Open the evaporator door. The evaporator door is the sheet metal that houses the evaporator fans. To open it remove the screws located on the right-hand side of the evaporator door, opposite to the hinges. The ozone generator is mounted on the inside of the evaporator door	
3	Remove the old lamp by gently pushing the lamp from the bottom side until enough of it is to grab.	
4	Extract the lamp from the top, pull to disconnect the wire harness, and replace the lamp	
5	Close and secure the evaporator door.	
6	Reconnect the main electrical power to the unit.	
7	Test the Sanitation cycle. To do so engage the sanitation cycle and let it run for 5 to 10 minutes. There will be a strong ozone smell inside the cabinet	



## Versatile, Dependable Walk-Ins & Blast Chillers



American panel is your trusted manufacturer for all your cold storage, blast chilling and shock freezing needs. Building on a 60-year family owned and operated heritage, American panel provides versatile, dependable custom crafted walk-in coolers, freezers, combination cold rooms and blast chillers.

American Panel is proud to offer the largest line of blast chillers and shock freezers on the market. 37 different freestanding models and an infinite number of integral configurations. HURRiCHiLL offers the easiest to use controls in the industry, blast chilling is complex but controlling it doesn't have to be. American Panel is the go-to source for all your blast chilling/shock freezing needs.

Find out more at [www.americanpanel.com](http://www.americanpanel.com)