



Project Name: _____

Item #: _____

Quantity: _____

Type: Modular Blast Chiller
Model: AP20BC-3T



Blast Chiller (Modular) - AP20BC-3T

Standard Features

PERFORMANCE:

- Blast chilling (soft or hard) lowers the food core temperature from 160°F to 38°F within 90 minutes.
- *Chilling times will vary somewhat, depending on the food quantity, initial temperature, density, moisture content, specific heat, and type of container.*
- The airflow has a high velocity, indirect pattern designed to cool all levels at identical rates.
- Time/temperature chilling rates meet or exceed all FDA, NSF, and state regulations.

TOUCHSCREEN CONTROLS:

- 7" glove-safe capacitive touchscreen
- Easily readable from across the kitchen
- User friendly interface and quick access to all functions
- Quick-start button for one touch operation
- Capable of automated defrost and sanitation cycles
- HACCP logger, data download via optional Wifi card or USB port
- Available cycles - Soft Chill, Hard Chill, Quick Start
- Three core temperature probes are provided

ASSEMBLY:

- Unit manufactured using cam-lock insulated panels that are sized for easy assembly and ingress
- Internal electrical connections done via quick connect male-female connectors to minimize field wiring

CABINET CONSTRUCTION:

- Constructed of polished type 304 stainless steel,
- 4" of CFC-free, high density polyurethane insulation.
- Fully rounded interior corners
- Removable magnetic door gasket.
- The cabinet floor is made of 2" thick insulated panels that are provided with NSF cove.
- 16" long external ramp
- Clearance: 15" at the top cabinet for service. 30.5" at the front for door opening.

REFRIGERATION SYSTEM:

- Refrigeration system is complete with all components including controls, evaporator, TXV and solenoid valves, and blower system
- E-coated (electro-deposition coated) multiple circuits evaporator designed specifically for blast chilling operation
- Wash-down type motorized impeller fans with sealed ball bearing and overload protection
- Hinged swing out vent panel for easy evaporator cleaning



Overview: American Panel's modular series of blast chillers and shock freezers make site restrictions a thing of the past. These units are assembled in the field, the same way a typical walk-in is erected. No more wondering how you're going to get that large piece of equipment through the door. The modular series also features a consolidated evaporator fan assembly. This places all of the components within the cabinet on one side, which greatly reduces the overall footprint of the unit. American Panel quality and precision in a flexible format to fit your needs. 7" glove safe capacitive touchscreen control allows for simple 3 step control, or use the customizable quick-start button for one touch operation.

Capacity

Up to 3 mobile racks (not included), maximum dimensions of 26"W x 32"D x 73.5"H.

Product Yield

600 lbs. - 160 - 38°F in 90 minutes

690 lbs. - 160 - 38°F in 120 minutes

Warranty - Chiller & Doors

3 year parts & labor standard on chiller & doors only.
Warranty excludes food probes.
For remote refrigeration warranty, see Options & Accessories

Certifications



Controller



Soft Chilling: The air temperature is held in the range of 28°F to 35°F, ideal for delicate food items. The chilling cycle is completed when the food core temperature reaches 38°F.

Hard Chilling: The air temperature is lowered to and held within a range of 10°F to 20°F. When the food core temperature reaches 60°F, the air temperature rises to a range of 28°F to 35°F. The chilling cycle is completed when the food core temperature reaches 38°F.

Shock Freeze: Not available on AP20BC-3T

Quick Start: Programmable single touch button to start a cycle. Used for the most popular settings for the customer. This allows for starting any chilling or freezing cycle with one touch..

ADDITIONAL FEATURES:

Thawing (Optional): Not available on AP20BC-3T

Holding: At the end of any cycle, the unit will automatically switch to a holding mode which will keep the food at holding temperature until the cycle is stopped.

Defrost: A heated defrost cycle is included within the unit's controller programming.

Product Names: Store up to 150 product names.

Dimensions

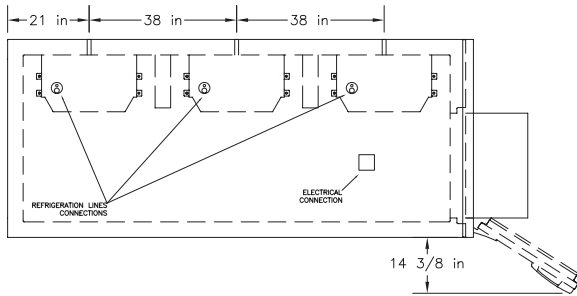

INSTALLATION: A detailed installation manual is provided. It must be carefully followed to ensure proper operation and to protect your rights under the warranty.

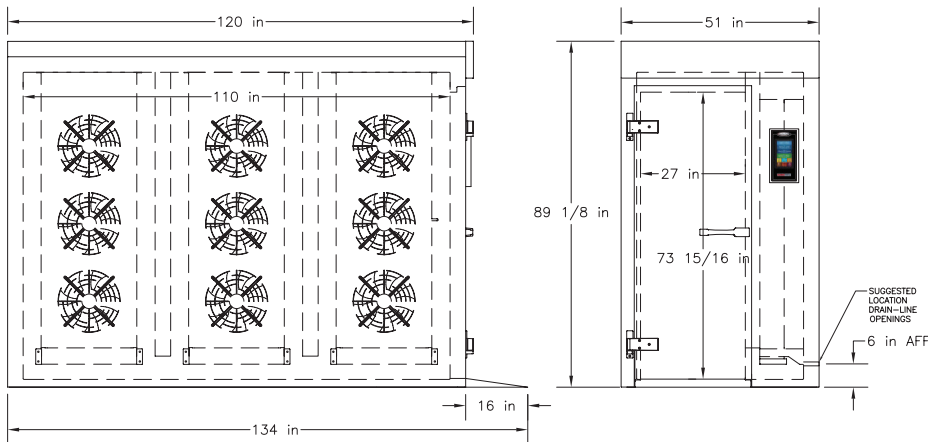

Specifications

Model	Electrical						Refrigeration Connections		Required Condensing Unit			Ship Weight
	V	Hz	PH	A	MCA	MOPD	Liquid Line	Suction Line	Type	Ref	BTU/HR*	
AP20BC-3T	208	60	1	22.7	30	30	3 x 1/2"	3 x 1 1/8"	Med.Temp. 40°F - -10°F	R404A	84,000	3,138 lbs.

* - Rating at 14°F SST and 105°F cond. temp.

Options and Accessories

- Cabinet Sanitation:** The ultraviolet system sanitizes all metal surfaces within the cabinet in a preset time of 30 minutes.
- USB HACCP Interface:** Use a standard USB thumb drive to easily download HACCP data. The information recorded includes date, time, cycle identification, recipe name, and product core temperature at prescribed intervals.
- Wi-Fi Connectivity:** Supported functions include peer-to-peer connectivity, remote monitoring over the local network, HACCP data download and alarm notifications via e-mail.
- 4" Insulated Floor Panels:** Allow for height increase to detail shown above.
- Remote Refrigeration:** RCU12BC, available in air cooled and water cooled configuration (5 year compressor, 1 year parts warranty provided).
- Prison Security Package**
- Extra Food Probes:** Three probes is standard, up to 1 additional food probes can be provided.
- Mobile Racks:** Model APR13-26 will accommodate 26 full size steam table pans (12"x20"x2 1/2") or 13 full size sheet pans (18"x26").
- Reversed Cabinet:** The entire assembly is manufactured so that it is a mirror image of the cabinet shown above.
- Second Door:** For pass-thru operation (increases depth by 16" for external ramp)
- Alternate refrigerant configuration available**
- Right hand hinge available**